INSTRUCTION MANUAL

HI 901 / HI 902

AUTOMATIC TITRATOR

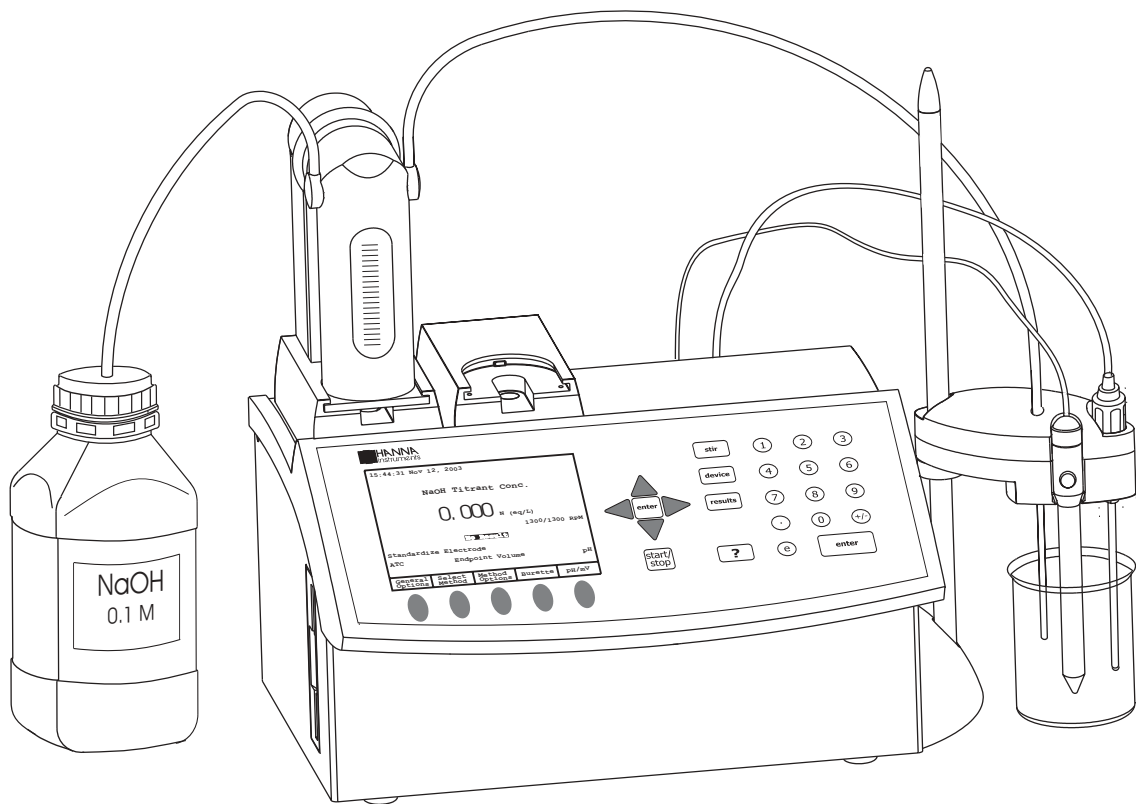

TABLE OF CONTENTS

Chapter 1.	INTRODUCTION
Chapter 2.	SETUP
Chapter 3.	USER INTERFACE
Chapter 4.	GENERAL OPTIONS
Chapter 5.	METHODS
Chapter 6.	TITRATION MODE
Chapter 7.	pH & mV MODE
Chapter 8.	AUXILIARY FUNCTIONS
Chapter 9.	MAINTENANCE, PERIPHERALS
Appendix 1.	TECHNICAL SPECIFICATIONS
Appendix 2.	BACK TITRATION (HI 902 only)
Appendix 3.	MULTIPLE EQUIVALENCE POINTS (HI 902 only)
Appendix 4.	ACCESSORIES

Dear customer,

Thank you for choosing a Hanna Instruments Product.

This instruction manual has been written for the HI 901 / HI 902 Titrator products.

Please read this instruction manual carefully before using the instrument. This manual will provide you with the necessary information for the correct use of the instrument.

© 2004 Hanna Instruments

All rights are reserved. Reproduction in whole or in part is prohibited without the written consent of the copyright owner, Hanna Instruments Inc., 584 Park East Drive, Woonsocket, Rhode Island, 02895, USA.

1 INTRODUCTION

HI 901 and HI 902 are automatic titrators with high accuracy, great flexibility and repeatability. The titrators are designed to perform a variety of potentiometric titrations, allowing the user to obtain both good results and high speed analysis.

The main attributes of these titrators are:

Flexibility	Support up to 100 titration methods (standard and user defined).
High accuracy	Precise dosing system (under 0.1% accuracy). Precise mV and pH measurements (± 0.1 mV and ± 0.001 pH accuracy). Interpolated end point volume.
Repeatability	Powerful built-in algorithms for equivalence point detection (first derivative and second derivative detection algorithms, filtered derivatives option, settable range for equivalence point detection). Fixed end point mV or pH.
Quick results	Standard titration methods. Pre-titration dosing feature. Dynamic / Linear dosing feature.
Complete report	The results are displayed directly in the selected units. Titration graph can be displayed on line and saved. User customized reports can be printed, saved on floppy disk or transferred to PC via RS232 interface. The sample information and data stamp are included in the report.
Direct measurements	The titrator can also be used for precise mV, pH and temperature measurements. Report of data logging is available for direct measurements.
GLP features	Up to 5 standardization points for the pH electrode. Reminders for titrant age and standardization expiration. Fields for specific annotations.
Large graphical display	7.5" B/W graphical display with backlight. Easy to view text and graphs. Lots of information on each screen.
Self diagnosis and integrated help	Integrated help is available. Self diagnosis features for peripheral devices including pump, valve, burette, stirrer. Error management with warning and error messages. Predefined troubleshooting titration methods.

This manual provides information regarding installation and functionality of the titrator, pointing out hints and refined operation suggestions.

Before beginning to work with the titrator it is recommended to become familiar with its various features.

Chapter 2. Contents

2	SETUP	2 - 3
2.1	Unpacking	2 - 3
2.2	Safety Measures	2 - 4
2.3	Installation	2 - 5
2.3.1	Titrator Front View	2 - 5
2.3.2	Titrator Rear View	2 - 5
2.3.3	Titrator Left-side View	2 - 6
2.3.4	Titrator Assembly	2 - 6
2.3.4.1	Assembling Stirrer Stand and Support	2 - 6
2.3.4.2	Attaching Stirrer	2 - 7
2.3.4.3	Connecting the Pump	2 - 8
2.3.4.4	Attaching Burette Blank Support	2 - 9
2.3.4.5	Attaching the Burette	2 - 9
2.3.4.6	Electrical Connections	2 - 10
2.3.5	Connection to Earth	2 - 11
2.3.6	Floppy Disk Drive	2 - 11

2 SETUP

2.1 Unpacking

The titrator and the accessories are shipped in a single box containing:

ITEM	QUANTITY
1 Titrator.....	1
2 Pump Assembly.....	1
3 Burette Assembly.....	1
• Burette (with 25 mL syringe)	
• Aspiration Tube with Fitting and Protection Tube	
• Dispensing Tube with Normal Dispensing Tip, Fitting, Protection Tube and Tube Guide	
• Tube Locks	
• Tool for Valve Fitting and Burette Cap Removal	
• Light Spectrum Protection Screen	
4 Stirrer Support, Stand, Collar and Positioning Screw.....	1
5 Burette Blank Support.....	1
6 Pump and Burette Locking Screws with Plastic Head.....	2
9 Temperature Sensor.....	1
10 Shorting Cap.....	1
11 Power Cable.....	1
12 RS232 Cable.....	1
13 Instruction Manual Binder.....	1
14 Start-up Disk (FDD with Titrator Installation Kit).....	1
15 HI 900 PC Application (FDD with Installation Kit).....	1
16 Quality Certificate.....	1

See **Appendix 4** section **A 4.3 Titrator components** for pictures.

If any of the items is missing or damaged, please contact your sales representative.

Note: *Save all packing materials until you are sure that the instrument functions correctly. Any damaged or defective items must be returned in their original packing materials together with the supplied accessories.*

2.2 Safety Measures

The following safety measures must be followed:

1. Always ensure that the power-supply cable is connected to a grounded main power plug.
2. Never connect or disconnect the pump assembly with the titrator turned on.
3. Verify that the burette and the attached tubing are as described in this manual (see *9.1 Burette Maintenance* section for more details).
4. Always check that the titrant bottle and the titration beaker are firmly sitting on a flat surface.
5. Always wipe up spills and splashes immediately.
6. Avoid the following environmental working conditions:
 - Severe vibrations
 - Direct sunlight
 - Atmospheric relative humidity above 95% non-condensing
 - Environment temperatures below 10°C and above 40°C and a normal humidity range
 - Explosion hazards
7. Have the titrator serviced only by qualified service personnel.

2.3 Installation

2.3.1 Titrator Front View

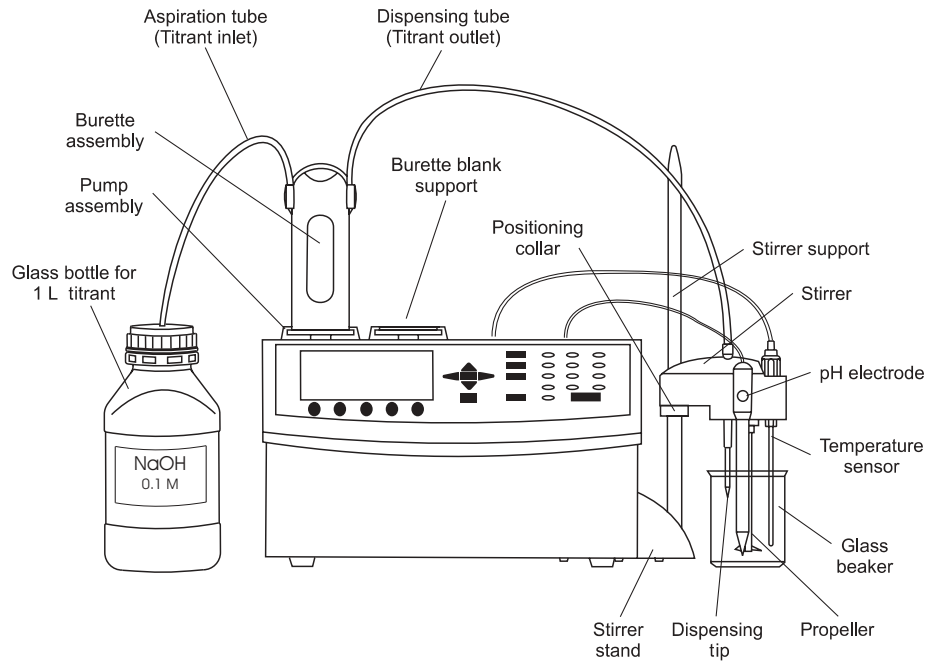

2.3.2 Titrator Rear View

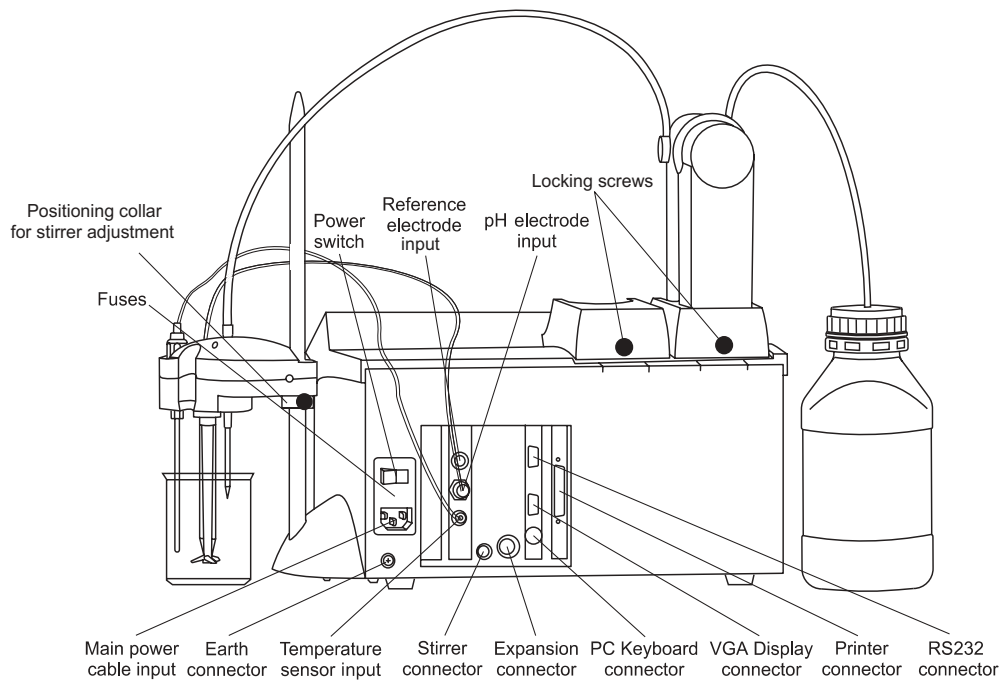

2.3.3 Titrator Left-side View

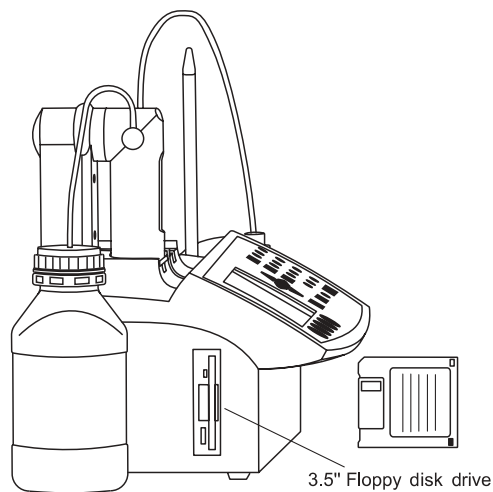

2.3.4 Titrator Assembly

Note: Assembly operations must be completed before connecting the titrator to the power-supply voltage!

2.3.4.1 Assembling Stirrer Stand and Support

Follow these steps to assemble the stirrer:

- Remove the screws (2) from the titrator chassis (1).
- Attach the stirrer stand (3) to the titrator chassis. Make sure to position the stirrer stand close to the wall of the chassis.
- Tighten the stirrer stand (3) using the previously removed screws (2).
- Screw the stirrer support (4) in the stirrer stand (3).

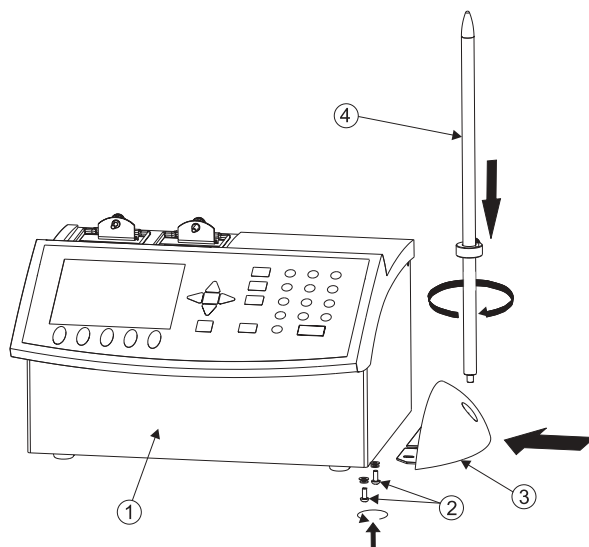

2.3.4.2 Attaching Stirrer

To attach the stirrer to titrator, follow these steps:

- Attach the propeller (2) to the stirrer (1) by pressing it onto the stirrer shaft.
- Insert the pH electrode (3) and temperature sensor (4) into the dedicated holes on the stirrer. Push them in until they are tightened in a stable position.

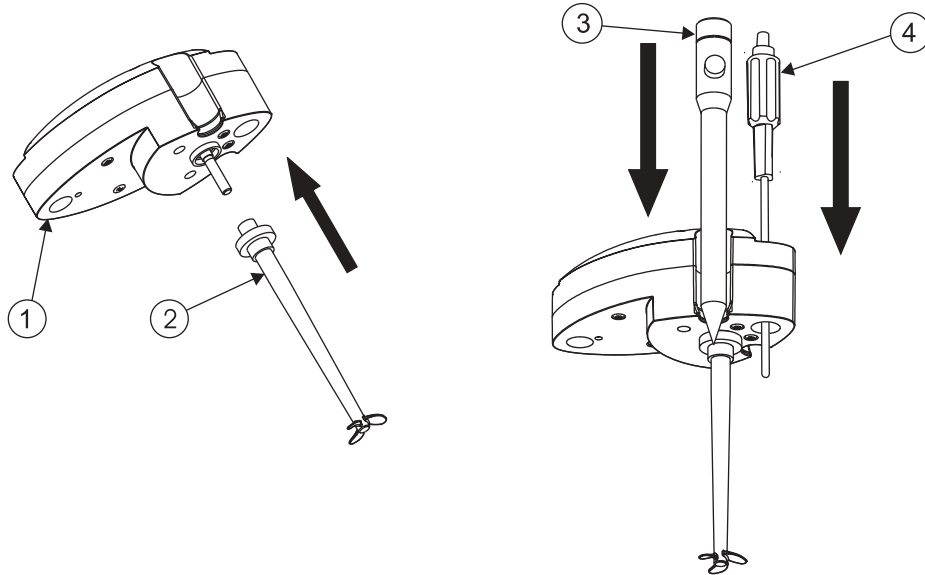

- Slide the stirrer on the stirrer support and set the height by tightening the screw located on the positioning collar (5).

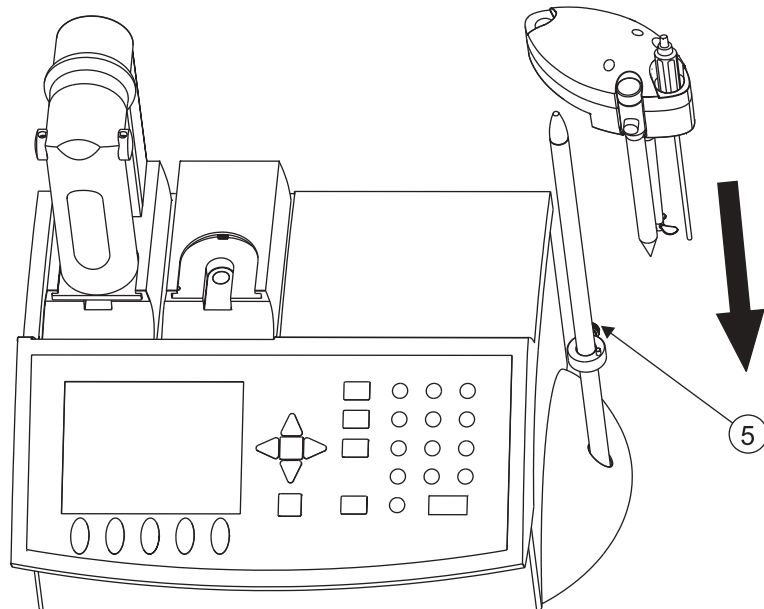

2.3.4.3 Connecting the Pump

To connect the pump, follow these steps:

- Retrieve the pump cable from inside the bay. The pump 1 connector is located in the left side bay.
- Connect the cable to the pump as shown in the figure below. The pump connector is located in the lower part of the pump, near the motor.

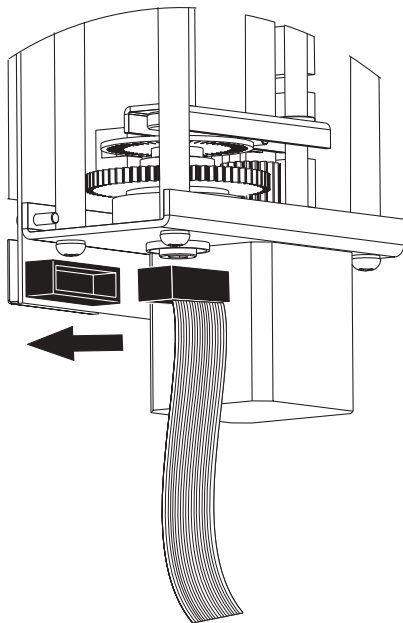

- Insert the pump (2) into the dedicated bay. Lower the pump until it reaches the lowest position, then slide it towards the front of the titrator chassis (1) until it is firmly latched.
- Secure the pump with the loking screw (3).

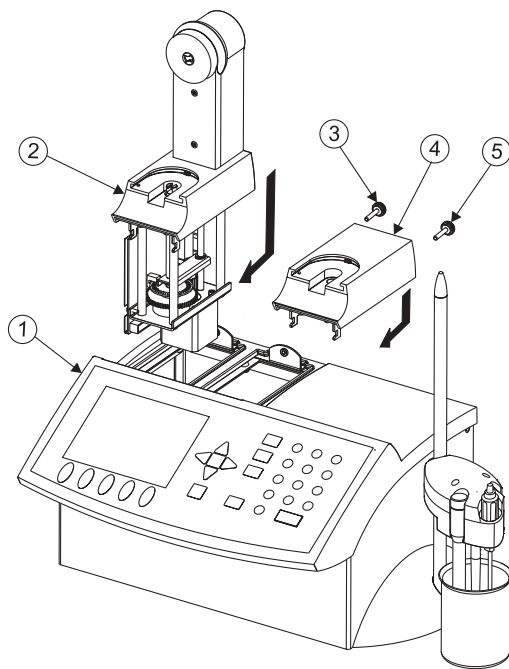

HI 902 only:

Follow the previous steps (2.3.4.3) to connect and attach the second pump.

2.3.4.4 Attaching Burette Blank Support (HI 901 only)

The burette blank support installation procedure is as follows:

- Insert burette blank support (4) in the dedicated bay - on the right side (see the previous picture). Lower the burette blank support until it reaches the lowest position, then push it toward the front of the titrator chassis (1) until it is firmly latched.
- Secure the burette blank support with the locking screw (5).

2.3.4.5 Attaching Burette

Make sure that the mark from the valve actuating cap and from the burette body are aligned as shown in the figure below.

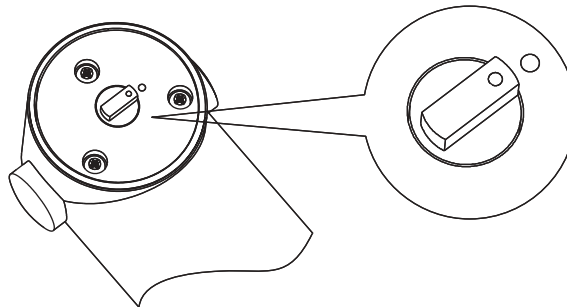

Take care to have a correct coupling between the pump plunger (2) and the syringe piston (1) and also when sliding the burette onto its support, consider the alignment between the valve actuating cap and the valve positioning wheel, as shown in the figure below.

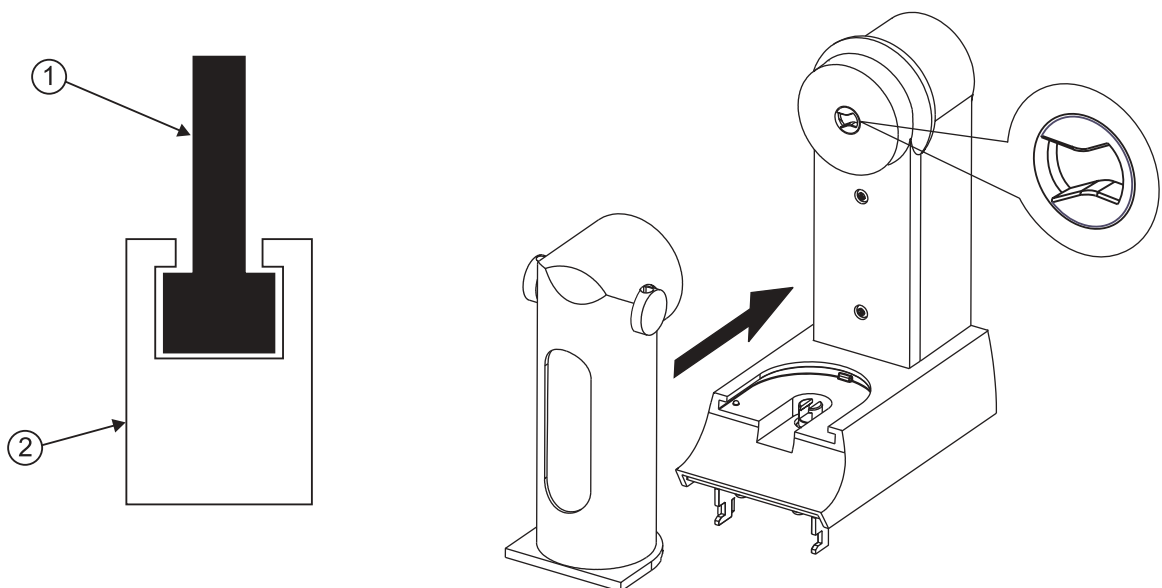

2.3.4.6 Electrical Connections

- Connect the pH electrode to the BNC connector (5).
- Connect the temperature sensor to the RCA connector (6).
- Connect the stirrer to the MINI-DIN connector (7).
- Connect the power-supply cable to the power supply connector (2).

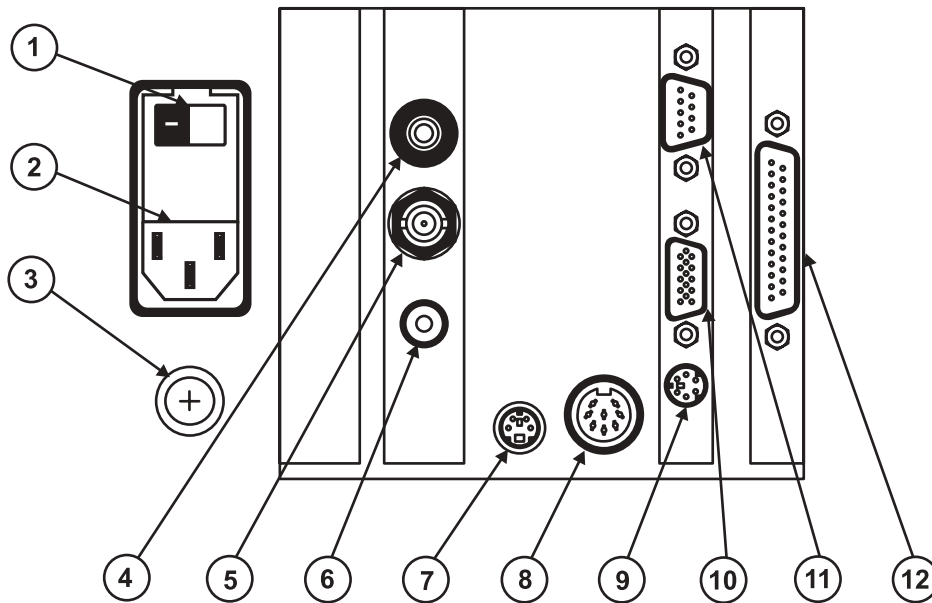

Nr	Function	Type of Connector
1	Power switch	
2	Power supply (115, 230 VAC, 50-60 Hz)	IEC Power line connector
3	Earth connector	5 mm screw
4	Reference electrode	Ø 4 mm banana socket
5	Connection for pH or ORP indicating half-cell or combination electrodes (pH/mV)	BNC socket
6	Temperature sensor	RCA socket
7	Stirrer	4-pin mini DIN
8	Connector for expansion device	8-pin DIN socket
9	External PC keyboard	6-pin mini-DIN (Standard PS2)
10	External display	Standard VGA display 15-pin socket
11	RS232 interface	Standard DB 9 pin socket
12	Printer standard	DB 25-pin socket

2.3.5 Connection to Earth

It is important that the titrator has a good connection to Earth. The titrator is properly grounded through the power cord and for added confidence the unit can be connected to Earth using the optional 5 mm screw and the nut connection located on the rear panel of titrator.

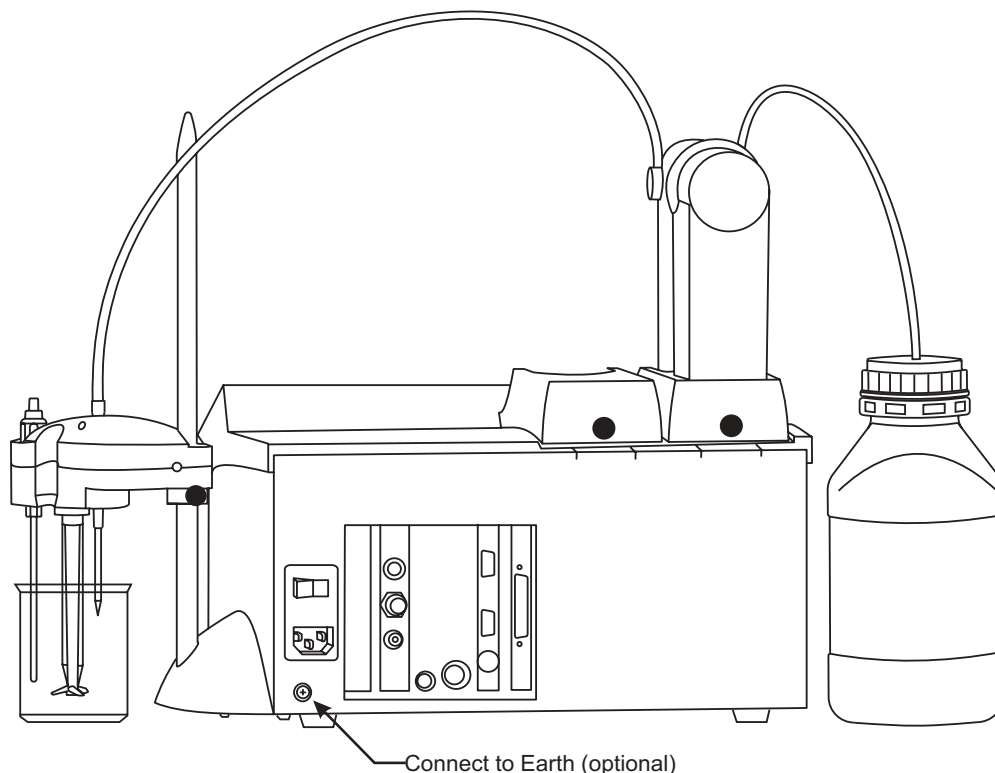

2.3.6 Floppy Disk Drive

Report files, new created (user) methods, standard methods can be transferred to and from the titrator using a standard 3.5" floppy disk.

Chapter 3. Contents

- 3 USER INTERFACE 3 - 3**
- 3.1 Start Up 3 - 3**
- 3.2 Description 3 - 4**
 - 3.2.1 Keypad 3 - 4
 - 3.2.1.1 Function Keys 3 - 4
 - 3.2.1.2 Option Keys 3 - 4
 - 3.2.1.3 Arrow Keys 3 - 5
 - 3.2.1.4 Numeric Keys 3 - 5
 - 3.2.1.5 Enter Key 3 - 5
 - 3.2.2 Display 3 - 5
 - 3.2.3 The Main Screen 3 - 6
- 3.3 Menu Navigation 3 - 7**
 - 3.3.1 Selecting an Option 3 - 7
 - 3.3.2 Selecting a Menu Item 3 - 7
 - 3.3.3 Entering Text 3 - 7
 - 3.3.4 Saving Modifications 3 - 8

3 USER INTERFACE

3.1 Start Up

Once the instrument is assembled and installed, please follow these steps to start up the titrator:

- Connect the instrument to a main power plug with ground wire. Make sure that the voltage of the main power and the one specified on the titrator are the same.
- Turn on the titrator from the power switch located on the back of the instrument.
- Wait until the titrator finishes the initialization process.
- Press when prompted or wait a few seconds for titrator to start.

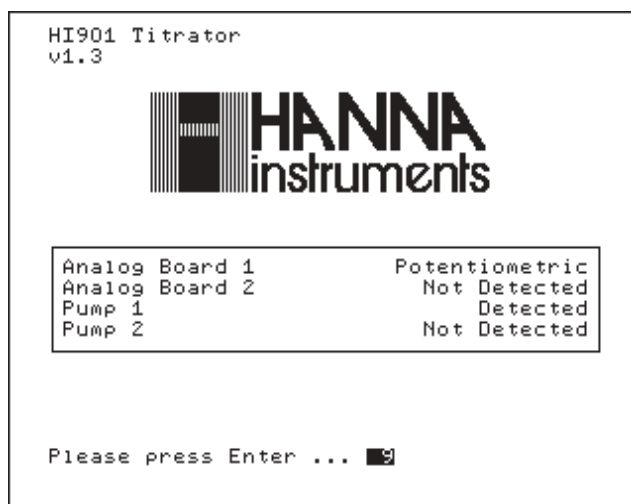

Note: All the performed initialization processes must be successfully completed. If one of them is terminated by a "Failed" message, restart the titrator from the power switch. If the problem persists, contact your dealer.

3.2 Description



This chapter describes the basic principles of navigating through the user interface, selecting fields and entering values from the keypad.



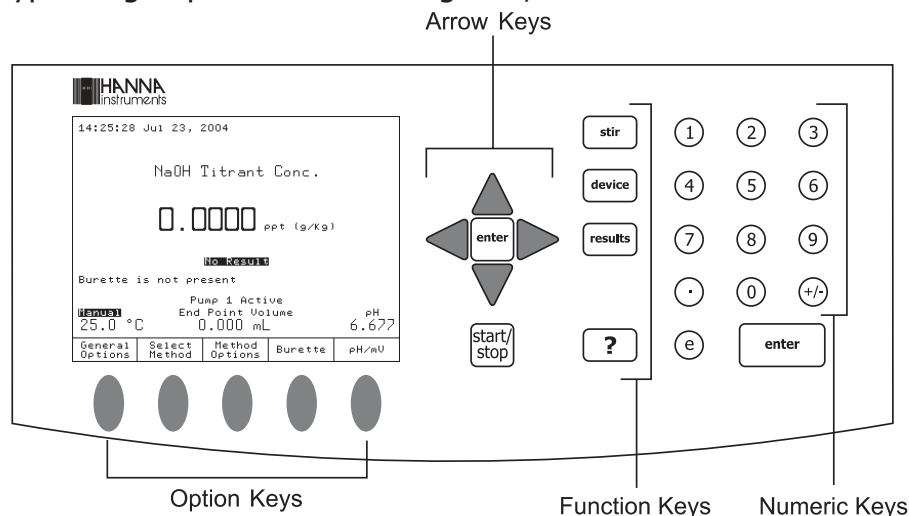

3.2.1 Keypad

The titrator's keypad is grouped into four categories, as follows:



3.2.1.1 Function Keys

If one of these keys is pressed, the associated function is immediately performed. The  and  keys are active only in specific screens:

-  Displays contextual Help
-  Turns the stirrer ON and OFF
-  Gives access to results menu
-  Reserved
-  Starts or stops a titration or data logging (when the titrator is in pH or mV mode)

3.2.1.2 Option Keys

These keys are assigned to the virtual-keys on the display. The significance of each option key depends on the menu displayed on the screen.

The function related to an underlined virtual-key can also be activated by pressing .

3.2.1.3 Arrow Keys

These keys have the following functions:

- Move the on-screen cursor.
- Increase and decrease the stirrer speed and other settings.
- In the alphanumeric screen, to select a letter or to navigate through menu options.

3.2.1.4 Numeric Keys

- Keys 0 to 9 - Used for numeric entries.
- +/- - Toggles between positive and negative values.
- .
- e - Initiates entry of exponent for scientific notation.

3.2.1.5 Enter Key

Both , keys perform the same functions:

- Accepts alphanumeric data entry.
- Executes the default (underlined) virtual option key.

3.2.2 Display

The titrator has a large graphical display with built-in backlight. The main screen with short explanations is presented below.

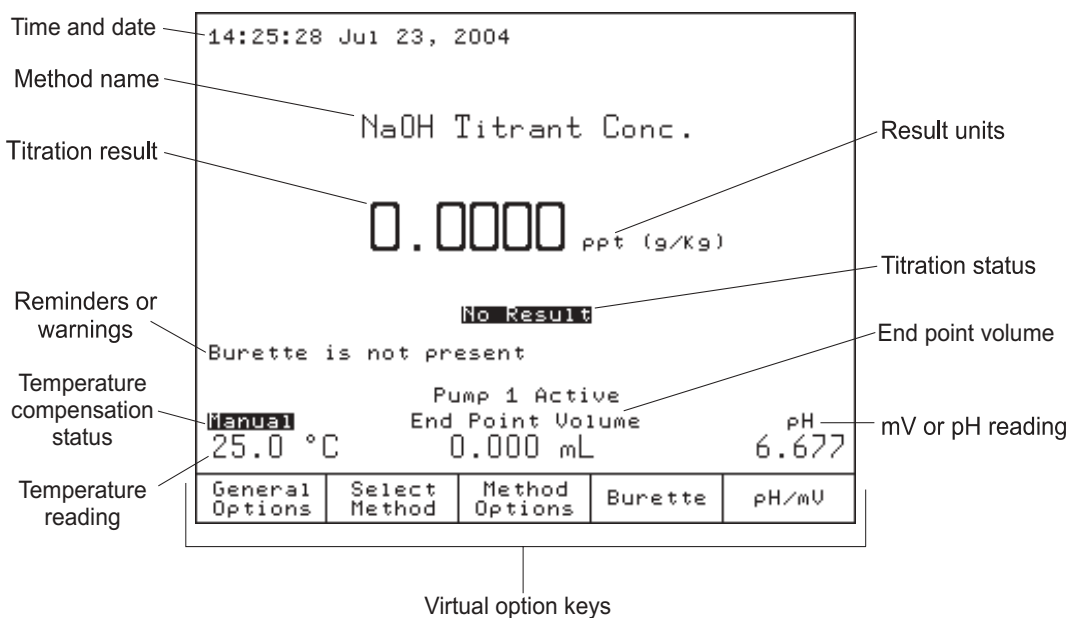

USER INTERFACE

The user interface contains several screens. For each titrator function, one or more screens are used.

Warnings and other critical information are displayed in **reversed** font.

3.2.3 The Main Screen

After start up and initialization, the first screen displayed is the main screen.

The main screen fields describe:

Method name:	Displays the name of the selected method
Time and date:	Displays the current date and time
Temperature reading:	Displays the measured temperature
ATC:	Indicates automatic temperature compensation
Manual:	Indicates manual temperature compensation
Manual:	Indicates manual temperature compensation as the temperature probe is not connected
Stirrer information:	Actual / Set stirrer speed is displayed in RPM. When stirrer is off, the stirrer information is not displayed
End point volume:	Displays the volume delivered to reach the titration end point. When no titration has been performed, the displayed volume is "0.000 mL"
Titration result:	Displays the titration result
mV or pH reading:	Displays the current readings. The sample reading will be: mV or pH respectively
mV:	Indicates actual potential reading
rel mV:	Indicates relative potential reading
pH:	Indicates actual pH value
Titration status:	Displays the status of the selected titration. When no titration was performed, No results is displayed
Reminders:	Indicates when a task needs to be performed and displays error or warning messages
Pump 1 Active:	Displays the current active pump

3.3 Menu navigation

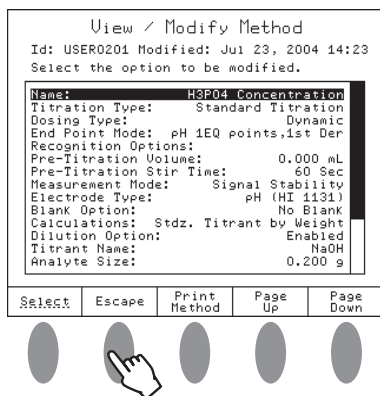
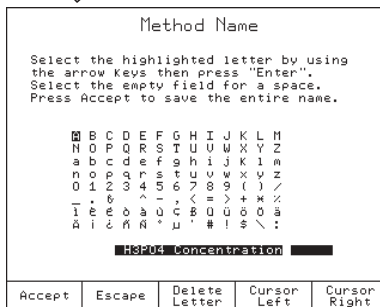
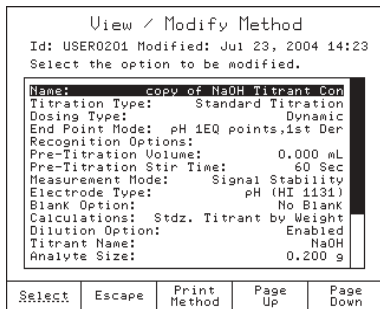
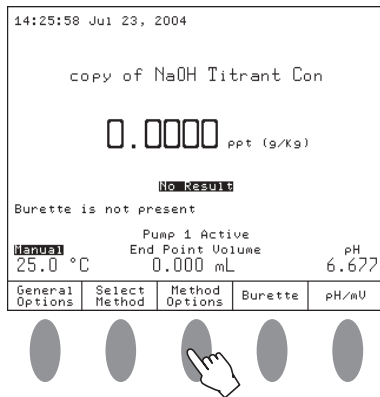

3.3.1 Selecting an Option

To select an option, simply press the option key below the virtual option key. For example, to access the **Method Options** screen press .

3.3.2 Selecting a Menu Item

To select an item from the menu screen use the arrow keys and to move the cursor.

When the menu is larger than the display, a scroll bar is active on the right side. The and keys can be used to scroll through the pages.

To activate the selected menu item, press or .

3.3.3 Entering Text

To enter text in an alphanumeric input box, first erase the previous text by using .

To enter a letter, highlight it using the arrow keys then press . Use the same procedure to enter the whole name.

For editing, use the and keys.

When editing is complete, press .

The method name will be updated and displayed in the name field of the **View/Modify Method** screen.

When all the desired parameters have been set, press .

USER INTERFACE

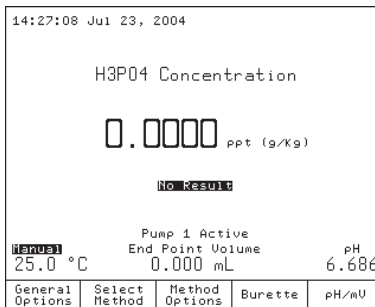
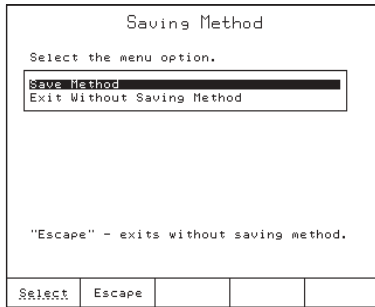

3.3.4 Saving Modifications

The **Saving Method** screen allows the user to save the modifications. To exit from **Saving Method** screen without saving, press or highlight the *Exit Without Saving Method* option and then press . To save the modifications highlight the *Save Method* option and then press .

After the method name is changed, it appears in the method name field.

Note: To access the contextual help menu, press at any time. Help is related to the displayed screen. Press or press again to return to the previous screen.

Chapter 4. Contents

4	GENERAL OPTIONS	4 - 3
4.1	Active Pump	4 - 3
4.2	Temperature	4 - 4
4.2.1	Temperature Source	4 - 5
4.2.2	Manual Temperature Setting	4 - 5
4.2.3	Temperature Units	4 - 6
4.3	Date and Time Setting	4 - 6
4.4	Display Settings	4 - 7
4.5	Beeper	4 - 8
4.6	Stirrer	4 - 8
4.7	Language	4 - 9
4.8	Daily Standardization Reminder	4-10
4.9	Periodic Standardization Reminder	4-10
4.10	Total Volume Alert	4-10
4.11	Titration Age Reminder	4-11
4.12	Save Files to Diskette	4-11
4.13	Restore Files from Diskette	4-12
4.14	Serial Link with PC	4-13
4.15	Reset to Default Settings	4-14
4.16	Update Software	4-14

4 GENERAL OPTIONS

The **General Options** screen gives access to options that are not directly related to the titration process or pH / mV measurement. To access this screen, press  from the main screen. The available menus are described below:

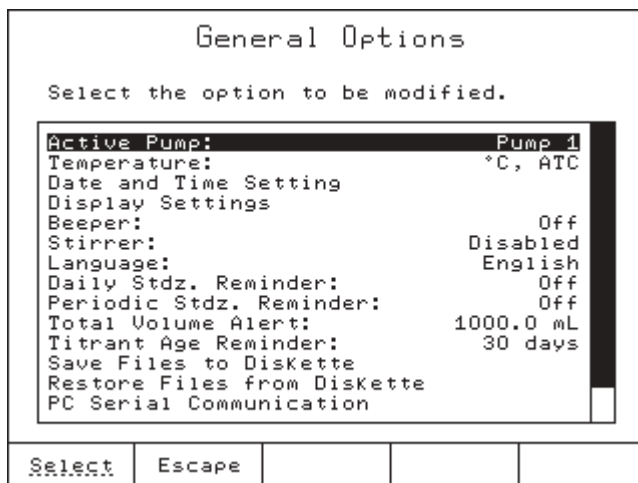

4.1 Active Pump



The HI 901 and HI 902 titrators can be equipped with one or two dosing systems (pump & burette). Only one pump can be active at a time. This option allows the user to set active either pump 1 or pump 2. Any further operations that involve the pump are referring to the active one.

Highlight the *Active Pump* option and then press . The **Active Pump** screen is displayed.

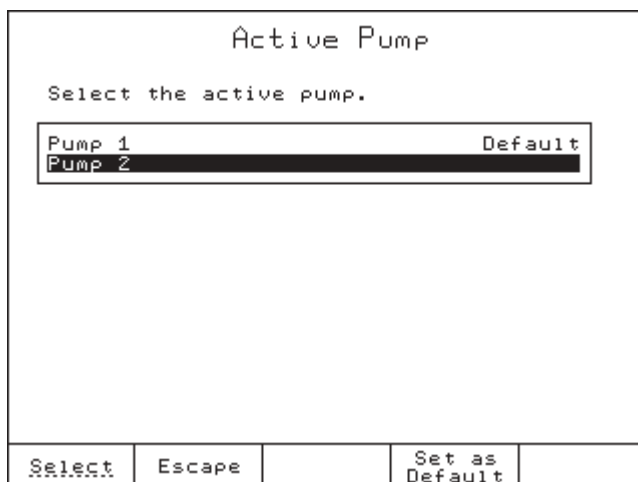
If there are two pumps connected to the titrator: use the arrow keys to select the active pump as follows:



GENERAL OPTIONS

- Highlight the pump to be activated.
- Press  and the highlighted pump is set as temporarily active (for the duration of the current running session). After the titrator is restarted, the active pump will be reset to the one set as default.
- Press  and the highlighted pump is set as active immediately in the current session and all following running sessions.

If only one pump is connected to titrator, the **Active Pump** screen will be as follows:

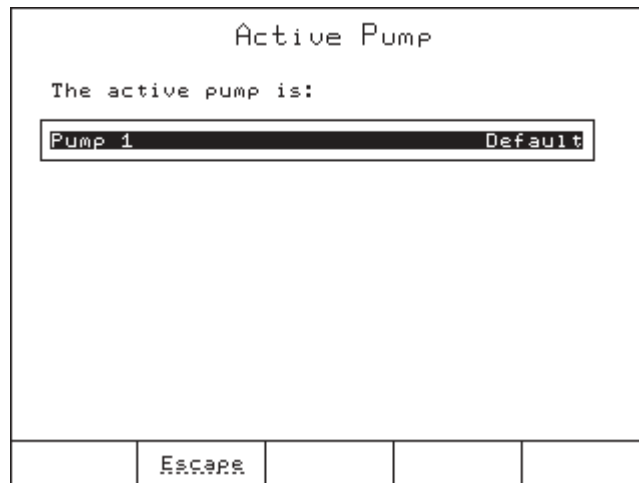

4.2 Temperature

The **Temperature Menu** screen allows selection of temperature source and other options related to temperature.

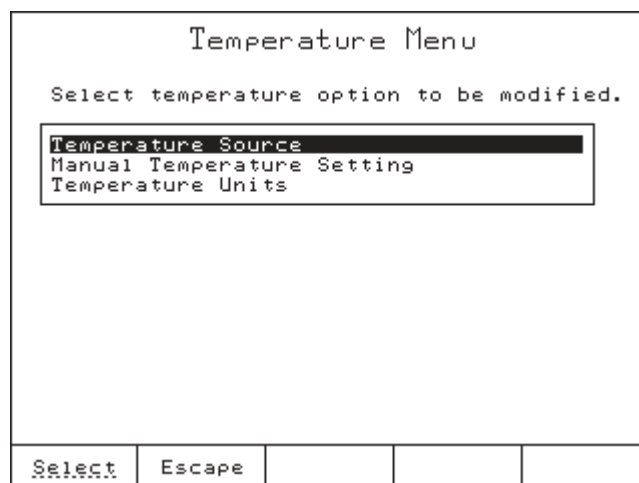

4.2.1 Temperature Source

The *Temperature Source* screen allows the user to select the temperature source, used for pH temperature compensation.

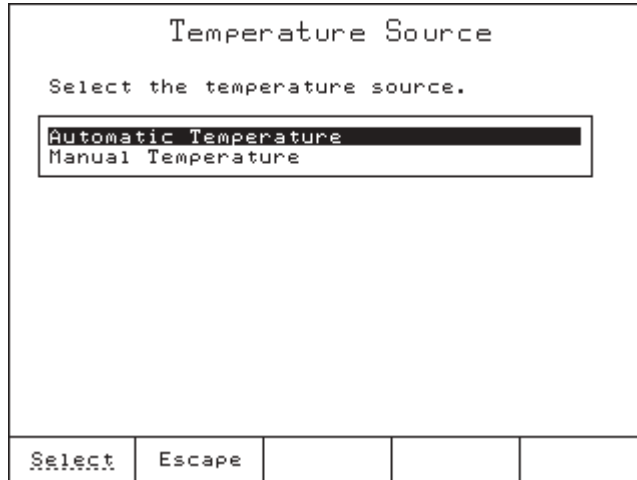

When the *Automatic Temperature Compensation* option is selected, the temperature displayed on the main screen is read by the temperature probe. Also the "ATC" icon is displayed.

When the *Manual Temperature* option is selected, a preset value of the temperature is used for temperature compensation and the "Manual" icon is displayed on the main screen.

4.2.2 Manual Temperature Setting

If the temperature probe is not connected the user can manually set the temperature used by the titrator for compensation. This can be done when the *Manual Temperature* option is selected (see 4.2.1 *Temperature Source* section).

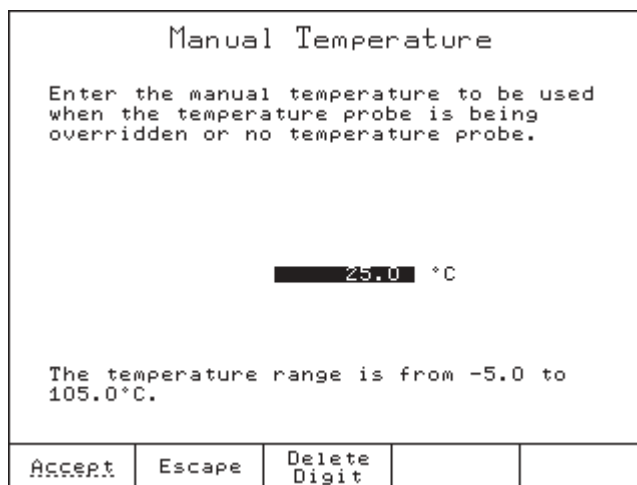

The temperature value can be set between -5 and 105 °C.

GENERAL OPTIONS

4.2.3 Temperature Units

The following temperature units can be selected.

Temperature Units										
Select the temperature units to be displayed.										
<table border="1"><tbody><tr><td>Celsius</td><td>-5.0 to 105.0°C</td></tr><tr><td>Fahrenheit</td><td>23.0 to 221.0°F</td></tr><tr><td>Kelvin</td><td>268.2 to 378.2 K</td></tr></tbody></table>					Celsius	-5.0 to 105.0°C	Fahrenheit	23.0 to 221.0°F	Kelvin	268.2 to 378.2 K
Celsius	-5.0 to 105.0°C									
Fahrenheit	23.0 to 221.0°F									
Kelvin	268.2 to 378.2 K									
Select	Escape									

The temperature ranges are as displayed in the *Temperature Units* screen. The titrator will automatically convert the measured temperature to the new unit.

4.3 Date and Time Setting

This screen allows the user to set the date and time.

Date and Time Setting				
Enter the date.				
2	6	2004		
day	month	year		
Enter the time.				
4	13	14		
hour	minute	second		
Press Next to move to the next entry.				
Accept	Escape	Delete Digit	Next	

By pressing

Next

 the cursor will cycle to the next field.

4.4 Display Settings

This screen allows the user to customize the viewing features of the display.

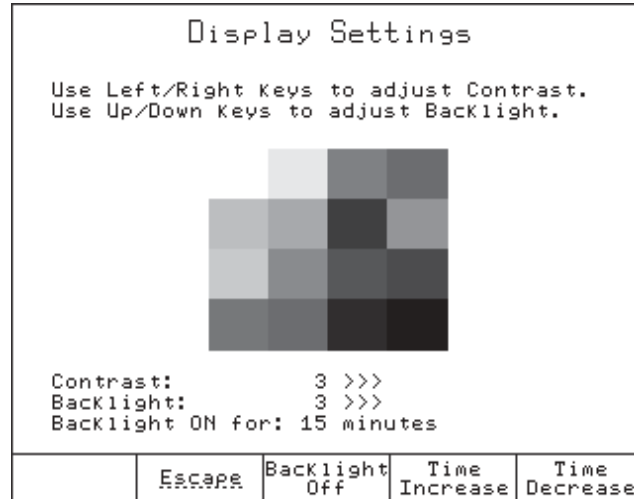

Option Keys:

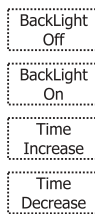

Turns the backlight off

Turns the backlight on

Increases the backlight saver time interval

Decreases the backlight saver time interval

The contrast can be adjusted using ◀ and ▶ keys.

The backlight intensity can be adjusted using ▲ and ▼ keys.

There are 8 gradual steps both for contrast and backlight intensity, ranging from 0 to 7.

A gray-scale grid ranging from black to white, is displayed in the center of the display, allowing an easy selection of the appropriate display lighting.

The backlight saver option protects the display during stand-by periods, when no keys have been pressed for a set amount of time.

If the display backlight is in Save mode, any keystroke will activate the display backlight without performing any action.

The range for backlight saver interval is between 1 and 60 minutes. To disable the backlight saver set it to 0 minute.

GENERAL OPTIONS

4.5 Beeper

This screen allows the beeper to be enabled (*Beeper On*) or disabled (*Beeper Off*).

```
Beeper
Select the option.
Beeper Off
Beeper On
Select  Escape  [ ]  [ ]  [ ]
```

The beeper will sound after a titration is completed, when an invalid key is pressed or when a critical error occurs during titration.

4.6 Stirrer

This screen allows the stirrer to be enabled or disabled.

```
Stirrer
Select the option.
Disabled
Enabled
Select  Escape  [ ]  [ ]  [ ]
```

4.7 Language

Select the language from the available languages listed in this screen.

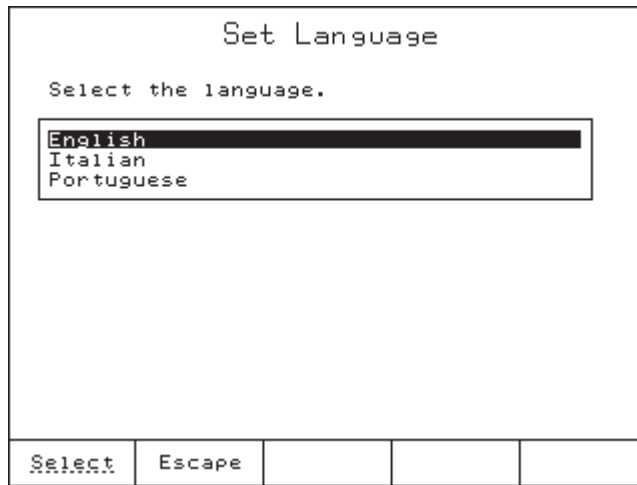

4.8 Daily Standardization Reminder

This screen allows a programmable reminder to appear when it is time to standardize the pH electrode. The "Standardize Electrode" reminder message will appear each day at the programmed time. Once standardization has been performed, the reminder will disappear until the next day.

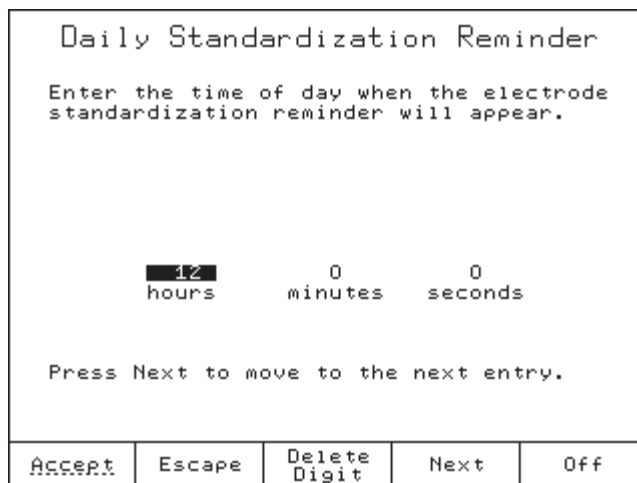

The reminder can be disabled by pressing .

GENERAL OPTIONS

4.9 Periodic Standardization Reminder

This screen allows a programmable reminder to appear when it is time to standardize the pH electrode. The "Standardize Electrode" reminder message will appear when it is time for the electrode to be re-standardized.

Once the new standardization has been performed, the reminder will disappear and the timer will reset.

Periodic Standardization Reminder				
Enter the time period that must be passed since the last standardization, whereafter the standardization reminder appears.				
10 days		12 hours		0 minutes
Press Next to move to the next entry.				
Accept	Escape	Delete Digit	Next	Off

The reminder can be disabled by pressing .

4.10 Total Volume Alert

The **Total Volume Alert** screen allows a programmable reminder to appear when it is time to add supplementary titrant to the glass titrant bottle. The current titrant volume data will decrease as the titrant is used.

Total Volume Alert				
Enter the amount of titrant available to the titration system from its reservoir. The mLs will decrease as the titrant is depleted.				
1000.0 mL				
A reminder will appear when less than 100 mLs of titrant volume is left.				
Accept	Escape	Delete Digit		Off

The "Low Titrant Volume" reminder message will appear when the available titrant volume has decreased under 100 mL.

After the new titrant volume has been set on titrator (in the **Total Volume Alert** screen), a warning message appears reminding the user to perform titrant re-standardization.

The reminder can be disabled by pressing .

The range is from 0 to 10,000 mL.

4.11 Titrant Age Reminder

This screen allows a programmable reminder to appear when it is time to verify the titrant concentration or to change the titrant due to concentration confidence loss.

Titrant Age Reminder				
Enter the number of days to pass since the last Titr. Vol. updating or the last Start pressing, whereafter the reminder appears.				
██████████ 30 days				
The range is from 0 to 31 days.				
Start	Escape	Delete Digit		Off

The "Check Titrant Concentration" reminder will appear when a number of days have passed since the total volume alert was set or since the timer was restarted by pressing .

The reminder can be disabled by pressing .

The range is from 0 to 31 days.

4.12 Save Files to Diskette

This menu allows the user to save files from the titrator to a floppy disk.

On the titrator, the available file types are:

- | | |
|-----------------------|--------------------|
| Standard Method Files | - HI*.MTD |
| User Method Files | - USER*.MTD |
| Report Files | - *.RPT |

If there is no diskette inserted in the floppy disk drive, the file manager menu is not available.



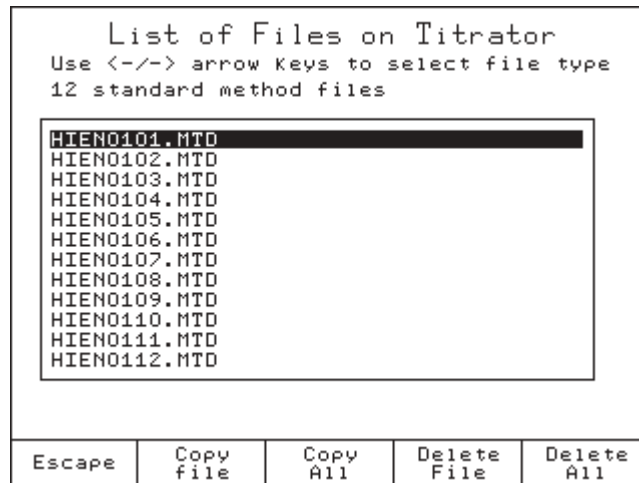

The selection of the file types can be performed with ◀ and ▶ keys. The number of files and each file name on the titrator will be displayed.

For example, if no report file was found on the titrator the message "0 report files" is displayed. Corresponding messages are displayed for the other file types.

GENERAL OPTIONS



The option keys allow the following operations:

-  Deletes the highlighted file
-  Deletes all currently displayed files
-  Copies the highlighted file from titrator to floppy disk
-  Copies all currently displayed files from titrator to floppy disk
-  Returns to the **General Options** screen

The status of the transfer ("successful" / "unsuccessful") and the file name of the currently processed file are displayed during copying or deleting. When copying or deleting files is over, "Press any key..." message appears and the instrument returns to the list of files.

4.13 Restore Files from Diskette

This screen allows transfer of files from the floppy disk to the titrator.

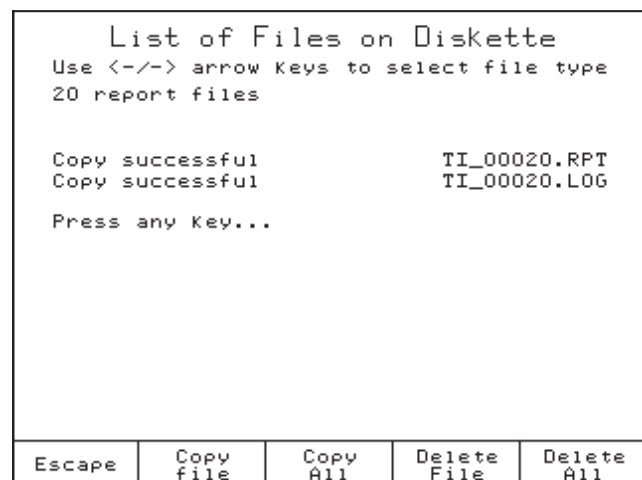
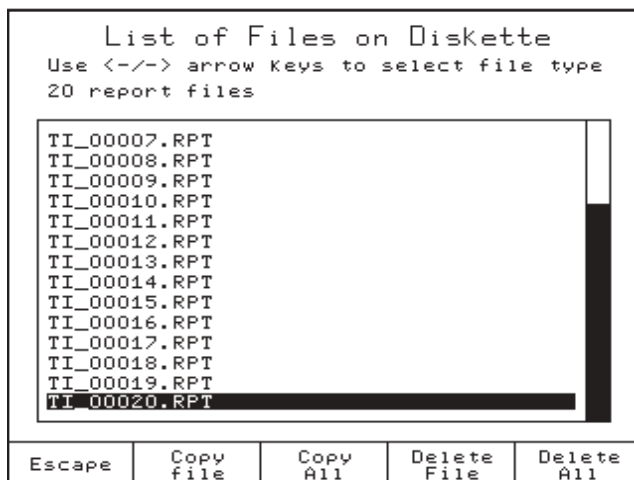





The file types that can be transferred are:

- Standard Method Files - **HI*.MTD**
- User Method Files - **USER*.MTD**
- Report Files - ***.RPT**

Selection of the file types can be performed with the ◀ and ▶ keys.

The number of files and the name of each file found on the floppy disk is displayed on the screen.

The option keys allow the following operations:

-  Deletes the highlighted file from diskette.
-  Deletes all currently displayed files from diskette.
-  Copies the highlighted file from diskette to titrator.
-  Copies all currently displayed files from diskette to titrator.
-  Returns to the **General Options** screen.

All the allowable operations are the same with the ones presented in *4.11 Save Files to Diskette* section.

4.14 Serial Link with PC

In order to use this feature, the serial RS232 cable is needed to be connected between the titrator and the PC. Make sure that HI 900 PC application is running on the PC.

In the **Serial Communication** screen:

“Active / Inactive”: shows the status of the serial link with the PC.

“Active” means that the titrator is using the RS232 serial communication with a PC and not with other device.

“Ready” shows that the titrator is able to communicate with the PC.

During transfer of any information between the PC and the titrator, “Transmit” and information about the percentage already transferred of current file are displayed.

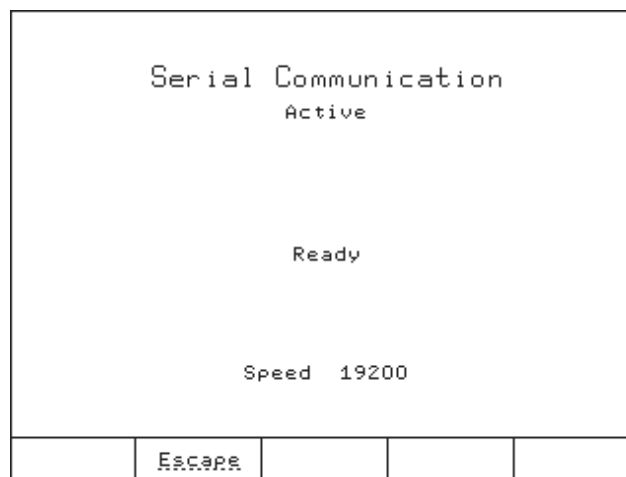

4.15 Reset to Default Settings

This option restores the manufacturer settings.

Confirmation of Reset				
Are you sure you want to reset the titrator to manufacturer settings?				
This will delete the standardization data, all the user methods and reports.				
Reset	Escape			

Note: Please be careful !!! This will also delete all the user created methods and restore all manufacturer settings such as titrator configuration, standard method parameters, etc.

4.16 Update Software

This screen allows the user to update the titrator software from a floppy disk.

Update Software				
Current version: HI902 v1.1				
New version: HI902 v1.2				
Are you sure you want to update the current software with the new version?				
Accept	Escape	Refresh		

Chapter 5. Contents

5	METHODS	5 - 3
5.1	Selecting Methods	5 - 3
5.2	Standard Methods	5 - 4
5.2.1	Upgrading Standard Methods	5 - 4
5.2.2	Deleting Standard Methods	5 - 5
5.2.3	Restore the Standard Methods to the Manufacturer Settings	5 - 5
5.3	User Methods	5 - 5
5.3.1	Creating User Methods	5 - 6
5.3.2	Deleting User Methods	5 - 6
5.4	View / Modify Method	5 - 7
5.5	Method Option	5 - 8
5.5.1	Naming the User Method	5 - 8
5.5.2	Titration Type (HI 902 only)	5 - 8
5.5.3	Dosing Type	5 - 9
5.5.3.1	Linear Dosing	5 - 10
5.5.3.2	Dynamic Dosing	5 - 11
5.5.4	End Point Mode	5 - 13
5.5.4.1	Fixed End Point (pH or mV)	5 - 13
5.5.4.2	Equivalence End Point (pH or mV)	5 - 14
5.5.5	Pre-Titration Volume	5 - 20
5.5.6	Pre-Titration Stir Time	5 - 21
5.5.7	Measurement Mode	5 - 22
5.5.7.1	Signal Stability	5 - 22
5.5.7.2	Timed Increment	5 - 24
5.5.8	Electrode Type	5 - 25
5.5.9	Blank Option	5 - 25
5.5.10	Imposed Current	5 - 26

METHODS

5.5.11	Calculation	5 - 27
5.5.11.1	Standard Titrations	5 - 27
5.5.11.2	Back Titrations (HI 902 only)	5 - 34
5.5.12	Dilution Option	5 - 39
5.5.13	Titrant Name	5 - 40
5.5.14	Titrant Concentration	5 - 40
5.5.15	Analyte Size	5 - 40
5.5.16	Analyte Entry	5 - 40
5.5.16.1	Fixed Weight or Volume	5 - 41
5.5.16.2	Manual Weight or Volume	5 - 41
5.5.17	Titrant 1 Entry (HI 902 only)	5 - 41
5.5.17.1	Calculated by Formula	5 - 41
5.5.17.2	Fixed by User	5 - 41
5.5.18	Maximum Titrant Volume	5 - 42
5.5.19	Stirring Speed	5 - 42
5.5.20	Potential Range	5 - 43
5.5.21	Volume/Flow Rate	5 - 43
5.5.22	Signal Averaging	5 - 44
5.6	Printing	5 - 44

5 METHODS

The titrator automatically performs a complete analysis. A complete analysis comprises sample preparation, dispensing of titrant solution, stirring, measuring and waiting times, recognition of the end point and storing titration results. All the parameters that a titration requires are grouped into a method. The titrator is supplied with a pack of standard methods. Using a floppy disk or connect the titrator to a PC using the HI 900 PC application, the methods (standard and user methods) can be upgraded, stored or deleted.

5.1 Selecting Methods

To select a method, press Select Method from the main screen. A list of available methods will be displayed.

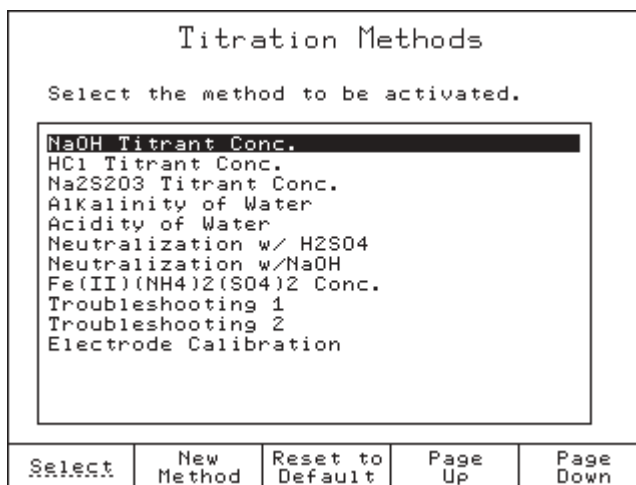

In the **Titration Methods** screen, you can view the list of all available methods (standard and user methods). If no user method has been defined, only standard methods are displayed.

METHODS

To select a method, highlight the method and press . The name of the selected method will be displayed on the main screen.

16:14:05 Jul 27, 2004				
NaOH Titrant Conc.				
0.0000 N (eq/L)				
No Result				
Pump 1 Active				
Manual	25.0 °C	End Point Volume	0.000 mL	pH 6.541
General Options	Select Method	Method Options	Burette	pH/mV

5.2 Standard Methods









The standard methods are developed by the manufacturer for the most common types of analysis. Also, each standard method can be used as a model to create a new user method. Only specific method parameters can be modified by the user (see *5.5 Method Options* section).

5.2.1 Upgrading Standard Methods

The titrator will accept up to 50 standard methods.

To upgrade the titrator from Floppy Disk or PC with new standard methods, follow the steps below:

Floppy Disk:

- Insert the methods installation diskette into the floppy disk unit.
- Press  from the main screen.
- Using  and  keys, highlight the *Restore Files from Diskette* option and choose .
- Using  and  keys, navigate through file types menu to find "standard method files". The list with available standard methods on the diskette will be displayed.
- Press the  or  key to upgrade the titrator with the standard methods.
- Press  to return to **General Options** screen.

PC:

You can upgrade the titrator with standard methods from a PC, using HI 900 PC application (see *4.14 Serial Link with PC* section).

5.2.2 Deleting Standard Methods

You can remove unnecessary standard methods from titrator following the next steps:

- Insert any diskette into the titrator.
- From the main screen press General Options.
- Using the \triangle and ∇ keys, highlight the *Save Files to Diskette* option and press Select;
- Using the \triangleleft and \triangleright keys, navigate through the file types menu to find "standard method files". The available standard methods will be displayed.
- Press the Delete or Delete All keys to remove unnecessary standard methods.
- Press Escape to return to **General Options** screen.

Also, you can remove standard methods from the titrator, using the HI 900 PC application (see 4.14 *Serial Link with PC* section)

5.2.3 Restore the Standard Methods to the Manufacturer Settings

You can restore the standard methods to the manufacturer setting by highlighting a standard method and pressing Reset to Default.

Warning: Be careful, by pressing Reset to Default you will also delete all the user methods.

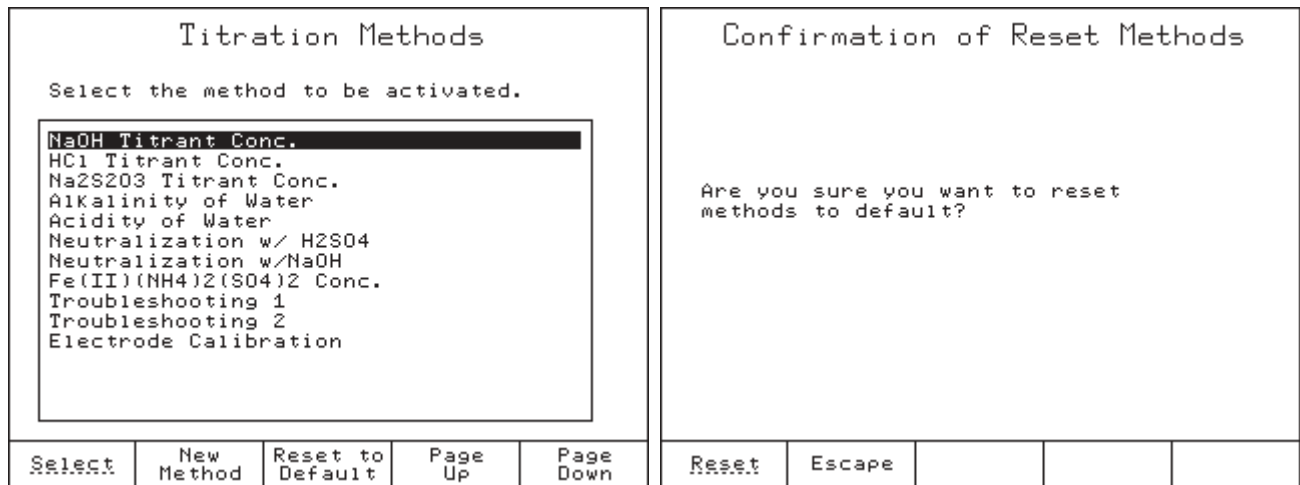

5.3 User Methods

User methods are defined by the user (usually by modifying a standard method). The user methods can be developed in accordance with the requirements of the user. All method parameters can be modified by the user.

METHODS

5.3.1 Creating User Methods

To create a new user method start from a standard or user method and follow these steps:

- Press from the main screen.
- Using the and keys, highlight an existing method from the methods list.
- Press . A new user method will be generated.
- Press to activate the new created user method.

<p>Titration Methods</p> <p>Select the method to be activated.</p> <div style="border: 1px solid black; padding: 5px;"><p>NaOH Titrant Conc. HCl Titrant Conc. Na2S2O3 Titrant Conc. Alkalinity of Water Acidity of Water Neutralization w/ H2SO4 Neutralization w/NaOH Fe(II)(NH4)2(SO4)2 Conc. Troubleshooting 1 Troubleshooting 2 Electrode Calibration copy of NaOH Titrant Con</p></div>					<p>16:14:31 Jul 27, 2004</p> <p>copy of NaOH Titrant Con</p> <p>0.0000 N (eq/L)</p> <p>No Result</p> <p>Pump 1 Active</p> <p>Manual End Point Volume pH</p> <p>25.0 °C 0.000 mL 6.539</p>				
Select	New Method	Delete	Page Up	Page Down	General Options	Select Method	Method Options	Burette	pH/mV

Note: Only a limited number of user methods can be generated. If the limit of standard and user methods (100 methods) is reached, a warning message will be displayed.

5.3.2 Deleting User Methods

To remove a user method, press from the main screen. Highlight the user method that you want to delete and press . A screen will appear in order to confirm the deletion. Press again to confirm, or press to cancel the operation.

<p>Confirmation of Method Deletion</p> <p>Are you sure you want to delete the selected method?</p> <p>copy of NaOH Titrant Con</p>				
Delete	Escape			

5.4 View / Modify Method

To modify the method's parameters, press from the main screen. A list of all the parameters for the selected method will be displayed. Using the and keys, highlight the option that you want to modify and choose .

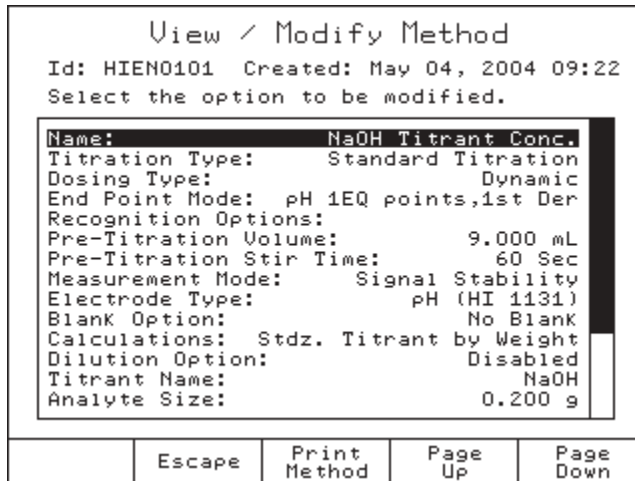

Save method:

From the **View / Modify Method** screen, press .

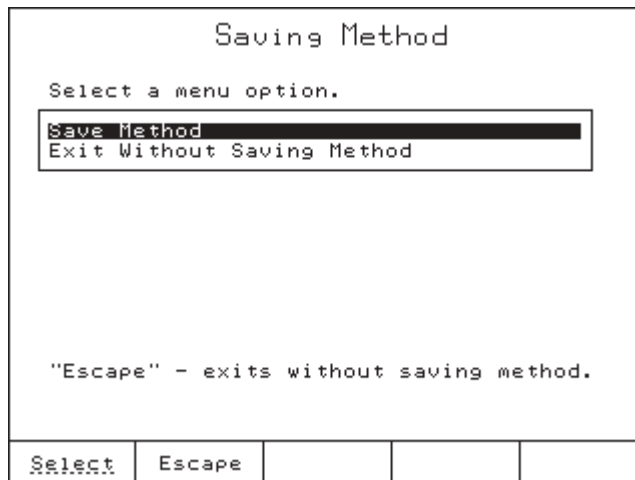

You can choose to save the modifications of the method parameters or to discard them.

5.4 Method Options

5.5.1 Naming the User Method

This option allows you to enter a name for the new method (up to 24 characters). Use the arrow keys to navigate through the character table. Press to add the highlighted character to the method name.

Method Name												
Select the highlighted letter by using the arrow keys then press "Enter". Select the empty field for a space. Press Accept to save the entire name.												
<input checked="" type="checkbox"/>	B	C	D	E	F	G	H	I	J	K	L	M
N	O	P	Q	R	S	T	U	V	W	X	Y	Z
a	b	c	d	e	f	g	h	i	j	k	l	m
n	o	p	q	r	s	t	u	v	w	x	y	z
0	1	2	3	4	5	6	7	8	9	()	/
-	.	0	^	-	,	<	=	>	+	*	%	~
!	@	#	\$	%	&	'	()	*	~	:	:
ä	i	ç	ñ	ñ	°	µ	'	#	!	\$	\	:
H3PO4 Concentration												
Accept	Escape	Delete Letter	Cursor Left	Cursor Right								

5.5.2 Titration Type (HI 902 only)

In order to make an analysis you have to choose the type of titration:

Titration Type				
Select the titration type.				
<input type="text" value="Standard Titration"/>				
<input type="text" value="Back Titration"/>				
Select	Escape			

Standard Titration

- A titration with a pH or mV equivalence point detection.
- A titration with fixed pH or mV end point.

Back Titration

A titration with a pH or mV equivalence point detection, consisting of two titration phases:

- Phase 1 – the sample is consumed by a known volume and concentration of titrant 1. A sufficient amount of titrant 1 is dispensed to surpass the equivalence point in order to react quickly with the sample.
- Phase 2 – the excess of titrant 1 is titrated with the titrant 2 to the equivalence point. Finally, the concentration of the sample will be determined.

Also, if the *Back Titration* option is chosen, the following settings must be selected:

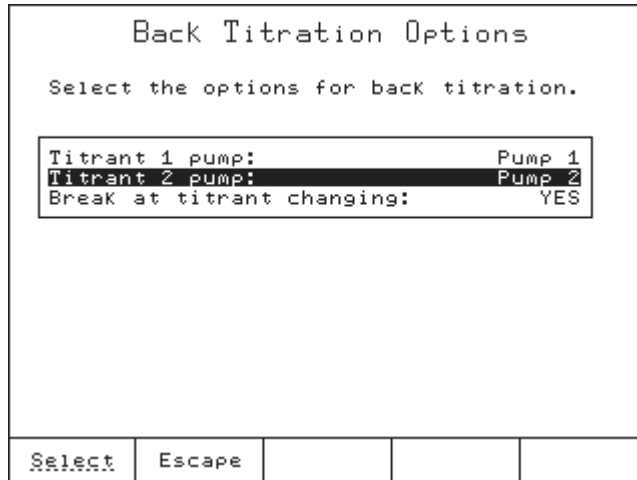

- *Titrant 1 pump*: select the pump used in phase 1 of the titration (*Pump 1*).
- *Titrant 2 pump*: select the pump used in phase 2 of the titration (*Pump 2*).
- *Break at titrant changing*: select "YES" to stop titration temporarily, between the first and the second phase of the back titration (you can do some tasks in order to perform the analysis: eg. boiling the sample in order to evaporate the carbon dioxide).

5.5.3 Dosing Type

The Titrator allows two dosing types: *Linear Dosing* and *Dynamic Dosing*.

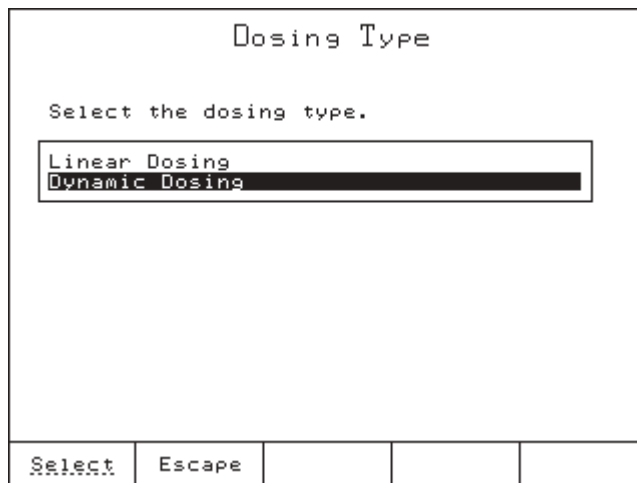

5.5.3.1 Linear Dosing

This type of dosing uses equal volume doses of titrant as shown in the graph below.

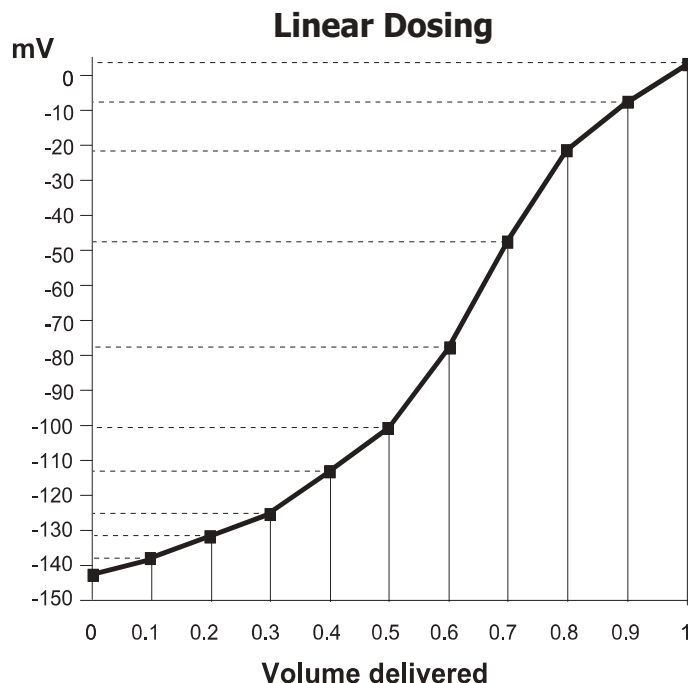

The *Linear Dosing* option is recommended for slower, difficult nonaqueous titrations or certain specific analysis.

Note: For steep and normal titration curves, smaller volume increments are recommended, to obtain many measured points around the equivalence point. For flat titration curves, larger volume increments are recommended for equivalence point detection.

To set the dosing volume, select *Linear Dosing* option and type the optimum dose.

```
Linear Dosing
Enter the titrant volume to be dispensed
at each increment.

0.500 mL

Press Help to view the valid domain for
this dispensing volume.

Accept  Escape  Delete
Digit
```

The allowed ranges for dosing volume are:
0.001 to 4.500 mL for a 5 mL burette
0.001 to 9.000 mL for a 10 mL burette
0.005 to 22.500 mL for a 25 mL burette
0.005 to 45.000 mL for a 50 mL burette

5.5.3.2 Dynamic Dosing

The titrant is added in volumes that depends on the proximity of the end point as shown in the graph below.

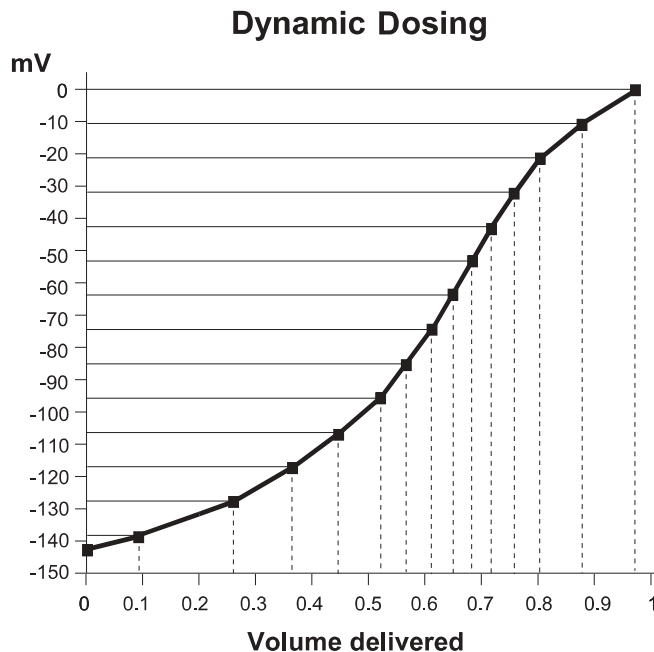

The titrator determines the titrant dose by trying to maintain a certain potential change (*delta E*) with each addition.

If the potential jump, after the titrant dose, is lower than the set *delta E*, the next dose volume is progressively increased until *max Vol* is attained. If the potential jump is still lower, the titration will continue with the *max Vol* doses.

If the potential jump, after the titrant dose, is higher than the set *delta E*, the next dose volume is progressively decreased until *min Vol* is attained. If the potential jump is still higher, the titration will continue with the *min Vol* doses.

METHODS

As a result, far from the end point, larger doses are made, reducing the total titration time. Closer to the end point, smaller doses are made, providing more data and higher accuracy in the critical end point region.

Dynamic Dosing				
Enter min Vol, max Vol and delta E.				
0.025 mL - min Vol				
0.500 mL - max Vol				
4.500 mV - delta E				
Press Next to move to the next entry.				
Accept	Escape	Delete Digit	Next	

The following parameters must be set:

min Vol: Sets the smallest dose volume to be dispensed during titration.

The *min Vol* must be greater or equal than:

0.001 mL for a 5 mL burette

0.001 mL for a 10 mL burette

0.005 mL for a 25 mL burette

0.005 mL for a 50 mL burette

max Vol: Sets the largest dose volume to be dispensed during titration.

The *max Vol* must be lower or equal to 4.000 mL.

delta E: Sets the fixed potential jump that has to be achieved after each titrant dose.

The allowed range is between 0.1 and 99.9 mV.

Recommendations for dosing parameters:

For titrations with stepper titration curves the recommended settings are:

delta E = 3.5 to 9 mV

min Vol = 0.010 to 0.025 mL (for a 25 mL burette)

max Vol = 0.075 to 0.250 mL (for a 25 mL burette)

For titrations with flat titration curves the recommended settings are:

delta E = 10 to 15 mV

min Vol = 0.050 to 0.150 mL (for a 25 mL burette)

max Vol = 0.400 to 0.600 mL (for a 25 mL burette)

In order to achieve maximum accuracy and reproducibility, it is recommended that 20% to 80% of the nominal volume of the burette is consumed. If lower or higher volumes of titrant are required, it is recommended to use the optimum burette volume as follows: 5, 10, 25 or 50mL.

5.5.4 End Point Mode

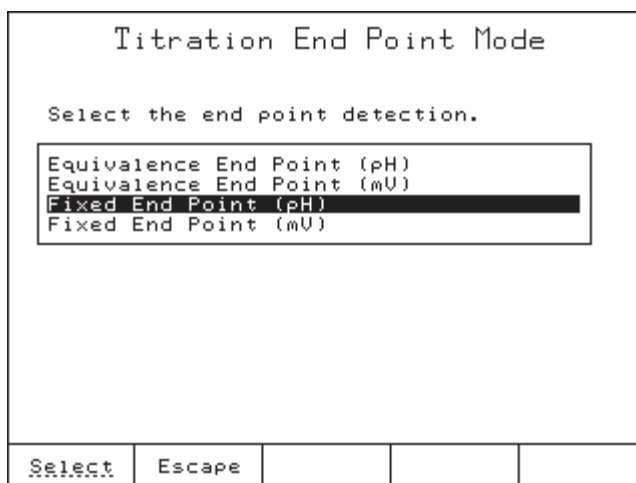

5.5.4.1 Fixed End Point (pH or mv)

Fixed End Point (pH):

The titration is normally terminated when the preset pH value has been exceeded. The reported end point volume is interpolated between the dispensed volume when pH is under the preset pH value and the dispensed volume when pH exceeded the preset pH value.

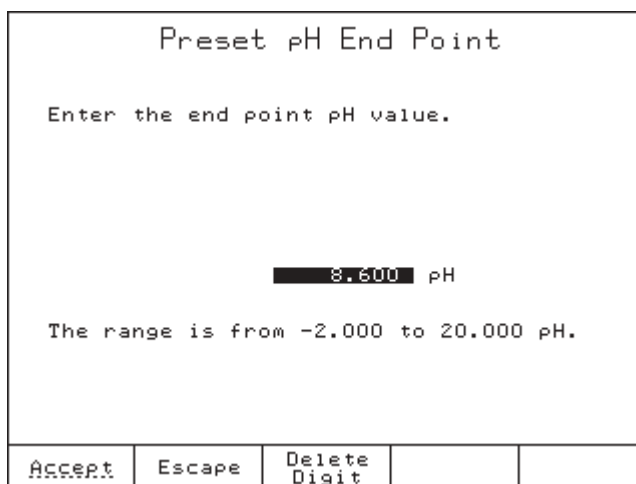

The range is from - 2.000 to 20.000 pH.

METHODS

Fixed End Point (mV):

The end point detection algorithm is the same as for pH, but the threshold value is expressed in mV.

```

Preset mV End Point
Enter the end point mV value.

      0.0 mV

The range is from -2000.0 to 2000.0 mV.

Accept  Escape  Delete
Digit

```

The range is from - 2000.0 to 2000.0 mV.

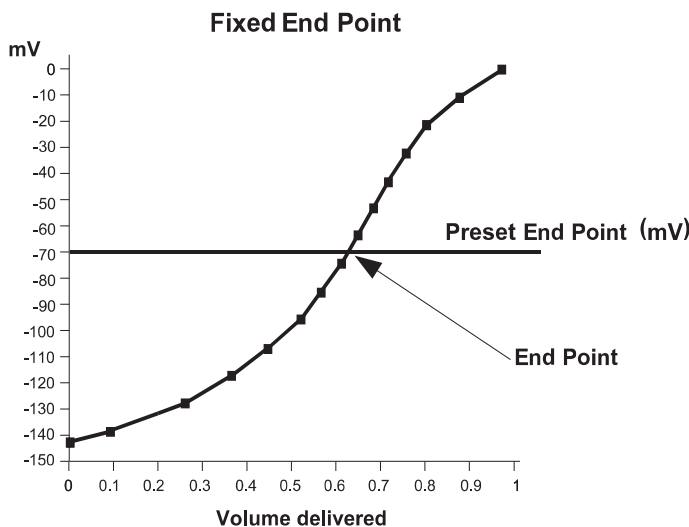

5.5.4.2 Equivalence End Point (pH or mv)

The titration is normally terminated when the equivalence point is detected (the point where the added quantity of titrant equals the quantity of analyte present in the sample, according to the chemical combination ratio).

Number of Equivalence Points (HI 902 only)

The titrator can perform a titration with more than one equivalence point. Up to 5 equivalence points can be detected.

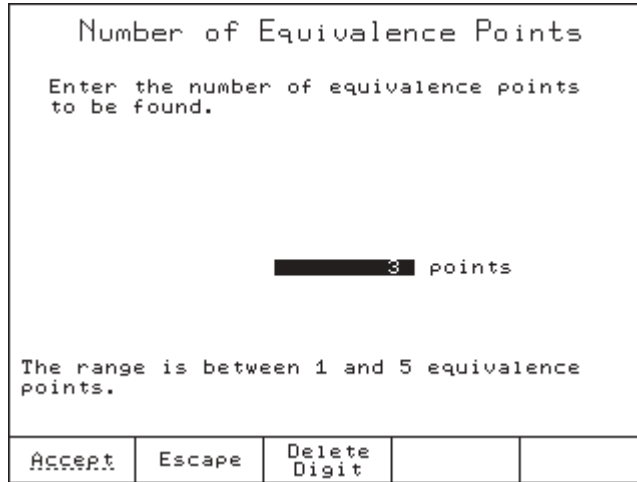

End Point Determination

The first and the second derivative of the S-shaped titration curve can be used to detect the equivalence point.

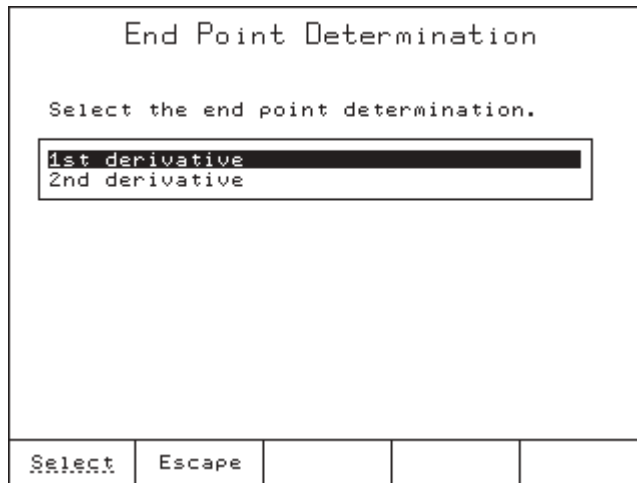

The equivalence point detection algorithm requires three more doses to be dispensed in the analyte after the equivalence point is reached.

The reported end point volume is a calculated value based on a number of points around the equivalence point.

The potentiometric S-shaped titration curve is the response in potential (mV) or pH between the indication of the electrode versus cumulated addition of titrant. The graph takes the shape of the S-character and can be expressed as mV or pH versus titrant volume.

The inflection point of the S-shaped titration curve is assumed to be the equivalence point of the chemical reaction.

METHODS

This is rigorously exact only for symmetric S-shaped titration curves. For non-symmetric curves, the effect of this theoretical error can be minimized by smaller doses (more measurement points) around the equivalence point.

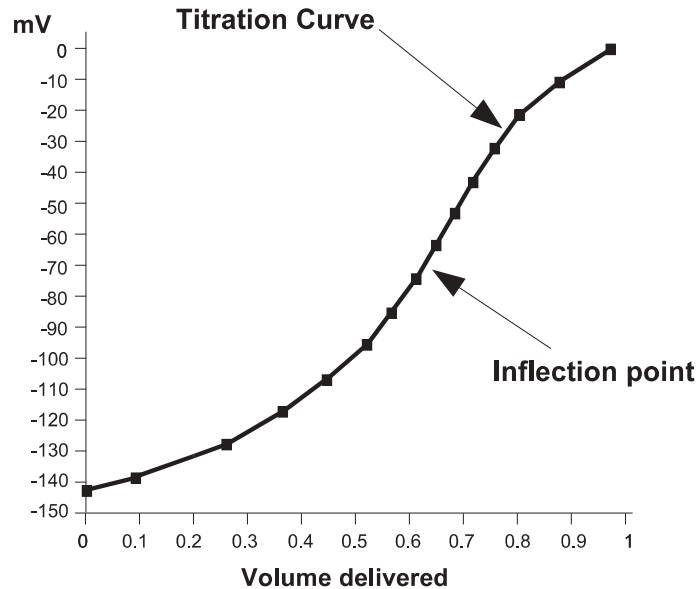

1st Derivative:

When first derivative is used to recognize the equivalence point, the point where the first derivative reaches the maximum value corresponds to the titration curve inflection point (EQP).

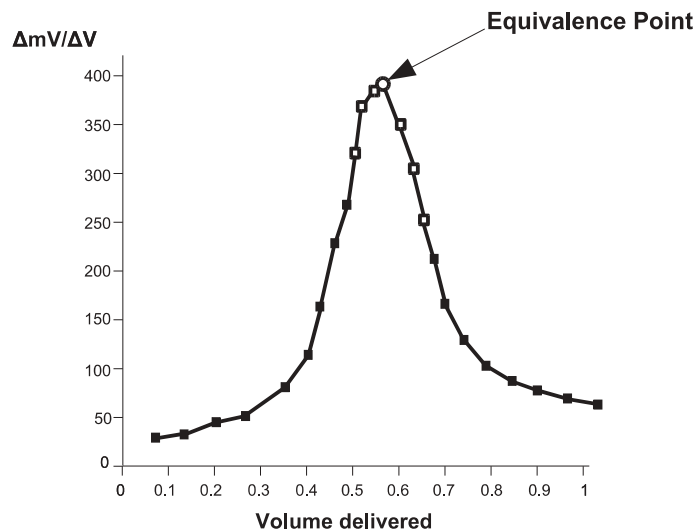

The detection algorithm searches for the maximum value of the first derivative. Also, the first derivative must be greater than the threshold value at the maximum point (see *Recognition Options* on page 5-17).

2nd Derivative:

When second derivative is used to recognize the equivalence point, the zero crossing point of the second derivative corresponds to the titration curve inflection point (EQP).

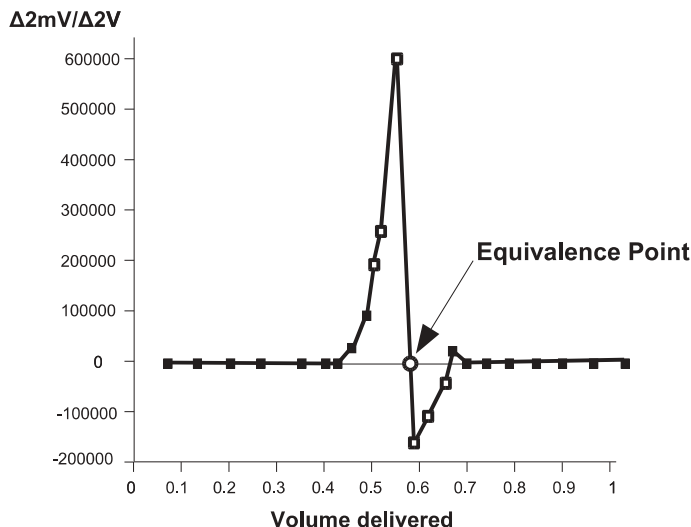

The detection algorithm searches for the point where the second derivative changes the sign. Also, the first derivative, corresponding to the checked point must be greater than the threshold value (see *Recognition Options* on page 5-17).

Recognition Options

The **Recognition Options** screen represents a set of parameters used to avoid false detection of the equivalence point. This could appear mainly due to the chemical system (involved titrant / sample chemical species and concentrations) and / or to the electrode response.

The **Recognition Options** screen is available only when *Equivalence End Point (pH or mV)* option is selected.

```
Recognition Options

Select the options for equivalence point
recognition.

Threshold          500 mV/mL
Range              NO
Filtered Derivatives NO

Select  Escape
```

METHODS

Threshold:

This parameter must be set by the user in accordance with the analysis.

The threshold represents the absolute value of the first derivative, expressed in $|\text{mV/mL}|$ (absolute value), below which the detection algorithm does not search for the equivalence point.

Threshold

Enter the threshold for equivalence point detection.

500 mV/mL

Recommended value is between:
 1 and 450 mV/mL for FLAT Curve,
 450 and 1800 mV/mL for NORMAL Curve,
 1800 and 9999 mV/mL for STEEP Curve.

Accept	Escape	Delete Digit	
--------	--------	--------------	--

Range is between 1 and 9999 mV/mL.

The recommended value for the threshold is around 40% of the estimated maximum absolute value of the first derivative.

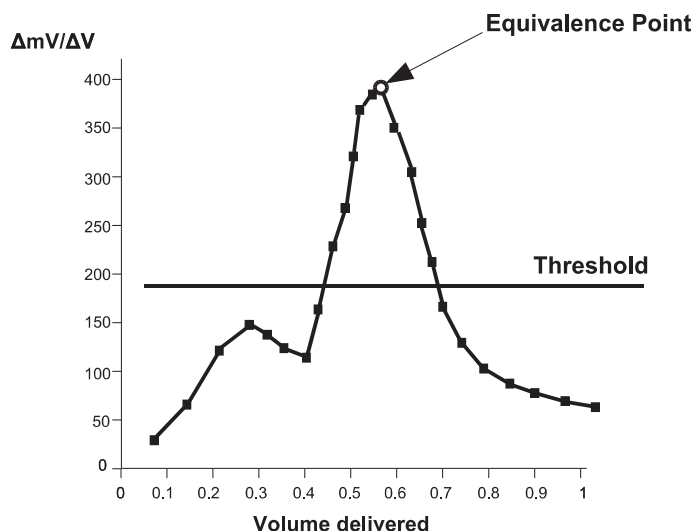

Depending on the titration curve profile, the following guiding ranges might be used:

TITRATION CURVE PROFILE	THRESHOLD $ \text{mV/mL} $
FLAT	1 to 450
NORMAL	450 to 1800
STEEP	1800 to 9999

Range:

Range is an optional feature for equivalence point recognition. It represents a set mV or pH range for equivalence point detection.

The *Range* option can be enabled by selecting **YES** in the **Range Options** screen.

<p style="text-align: center;">Range Options</p> <p>Select option for equivalence point range.</p> <div style="border: 1px solid black; padding: 2px; width: fit-content;"> <p>NO YES</p> </div> <p>"NO" - without equivalence point range. "YES" - with equivalence point range.</p>					<p style="text-align: center;">Range Limits</p> <p>Enter Limit 1 and Limit 2 for range.</p> <p style="text-align: center;">-2.0 mV - Limit 1 20.0 mV - Limit 2</p>				
Select	Escape				ACCEPT	Escape	Delete Digit	Next	

Limit 1 - The first limit of the range attained during the titration:
 This range can be from -2.000 pH to 20.000 pH (for *pH equivalence point*).
 This range can be from -2000.0 mV to 2000.0 mV (for *mV equivalence point*).

Limit 2 - The second limit of the range attained during titration:
 This range can be from -2.000 pH to 20.000 pH (for *pH equivalence point*).
 This range can be from -2000.0 mV to 2000.0 mV (for *mV equivalence point*).

The Limit 2 value must not be equal to the Limit 1 value.

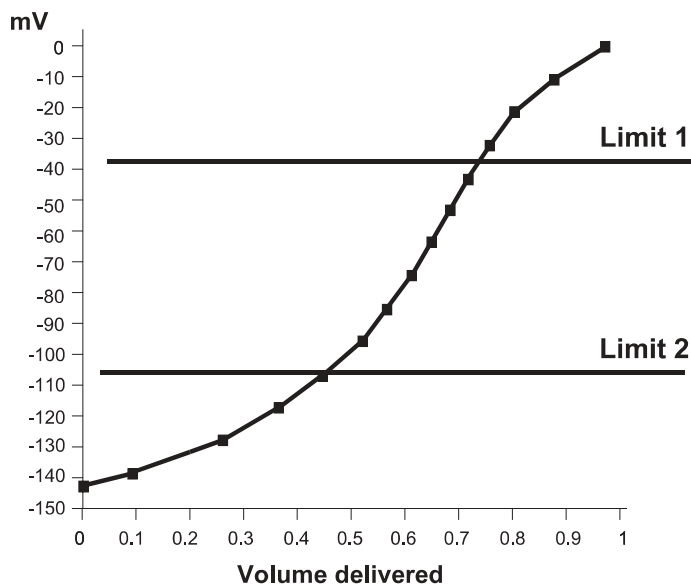

METHODS

Filtered Derivatives:

Filtered Derivatives is an optional feature for equivalence point recognition.

This option adds a filtering procedure in the 1st and 2nd derivative computation algorithm that reduces the influence of pH or mV noise.

The *Filtered Derivatives* option can be enabled by selecting **YES** in the **Filtered Derivatives Option** screen.

```
Filtered Derivatives Option
Select option for filtered derivatives.
NO
YES
"NO" - without filtered derivatives.
"YES" - with filtered derivatives.
Select  Escape
```

Noise can appear due to:

- Chemical system properties (sample, titrant, solvent), such as slow chemical reactions or unbuffered samples such as wastewater, tap water, wine.
- Electrode response.
- Incorrect method parameters settings such as *Signal Stability*, *Stirring Speed*, etc.
- Too small titrant doses.

Note: *Even if false equivalence point detection has been highly diminished, a shift of the end point volume might sometimes occur due to filtering. The shift is often at the level of 1 or 2 doses from the real equivalence point volume. For fast titrations and small doses this is a useful option.*

5.5.5 Pre-Titration Volume

During a regular titration, the equivalence point is reached after many doses are dispensed. Most of these doses simply take up extra time while having no relevance for equivalence point detection.

Pre-titration volume adds a large initial dose to jump directly to the proximity of the equivalence point.

This first dose occurs after the pre-titration stir time is completed.

The valid pre-titration volume is between the ranges shown below:

0.001 to 4.500 mL for a 5 mL burette

0.001 to 9.000 mL for a 10 mL burette

0.005 to 22.500 mL for a 25 mL burette

0.005 to 45.000 mL for a 50 mL burette

Pre-Titration Volume				
Enter the initial titrant volume to be dispensed.				
9.000 mL				
Press Help to view the valid ranges for the pre-titration volume.				
Accept	Escape	Delete Digit		

If no pre-titration volume is used, 0.000 mL should be entered.

Note: A pre-titration volume is highly recommended whenever possible. When fewer linear doses are used the overall titration duration considerably shortens.

5.5.6 Pre-Titration Stir Time

When this option is enabled, the sample is mixed for a period of time before the titration begins. This allows the sample to become homogeneous.

The range is from 0 to 180 seconds.

Pre-Titration Stir Time				
Enter the initial mixing time prior to the start of the titration.				
10 seconds				
The range is from 0 to 180 seconds.				
Accept	Escape	Delete Digit		

If 0 seconds is entered, the *Pre-Titration Stir Time* option is disabled.

5.5.7 Measurement Mode

During titration, the acquisition of the potential (mV) value of the solution, can be performed in two ways, by using either *Signal Stability* or *Timed Increment* option.

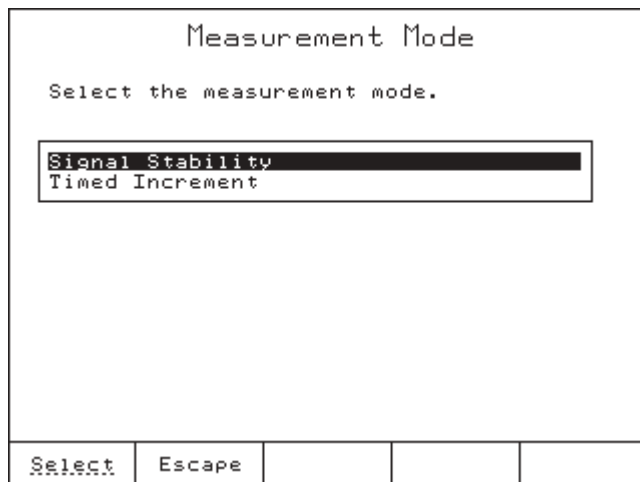

Addition of the next dose is performed immediately after the potential is measured.

5.5.7.1 Signal Stability

When *Signal Stability* option is selected, the titrator acquires the potential (from solution) only when the stability condition is reached.

The response of the electrode for each added dose and the principles of the stability window are plotted below and described on the following page.

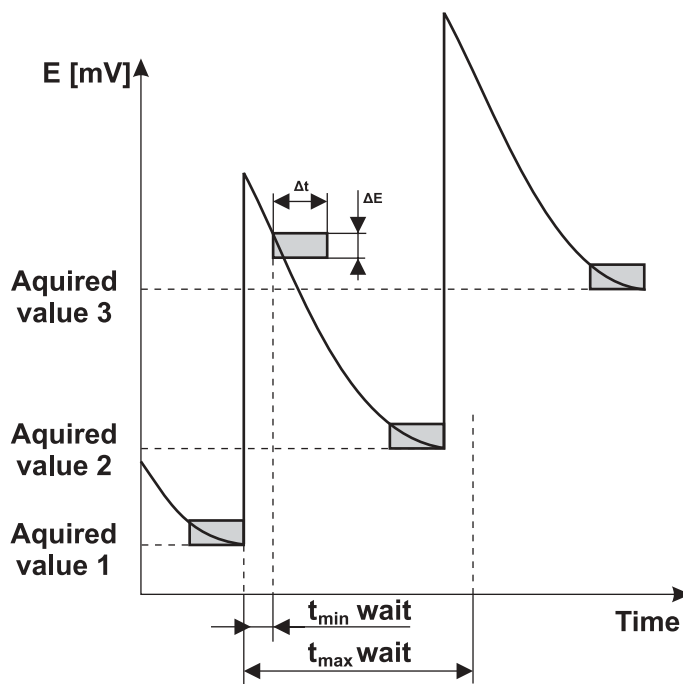

The signal stability window (condition) represents the time interval Δt during which the potential measured in solution (mV) is confined inside the potential interval ΔE (see the boxes on the chart).

The new signal value is acquired if the stability condition is reached but not before the minimum waiting time (*t min wait*) has elapsed.

If the *t max wait* time has elapsed and the stability condition is not reached, the potential is acquired (and a new dose is added).

```
Signal Stability
Enter mV variation (delta E) in the time
interval (delta t) min and max wait time
period to the next sample measurement.

  0.3 mV      - delta E
  1.5 seconds - delta t
   5 seconds - t min wait
  30 seconds - t max wait

Accept  Escape  Delete
                Digit  Next
```

delta E - is the height of the signal stability window.
The range is from 0.1 to 99.9 mV.

delta t - is the width of the signal stability window.
The range is from 0.5 to 10.0 seconds.

t min wait - is the minimum elapsed time before stability check. This is also the minimum elapsed time between two doses.
The range is from 2 seconds to *t max wait* time.

t max wait - is the maximum elapsed time between two successive doses. If the *t max wait* has elapsed, a new dose is added even if the condition of signal stability is not reached.

The range is from *t min wait* time to 180 seconds.

5.5.7.2 Timed Increment

When *Timed Increment* option is selected, the acquiring of the potential (mV) value from the solution is made at a fixed time interval (no signal stability check).

The time period between two acquisitions must be set according with the used reaction and the time response of the electrode.

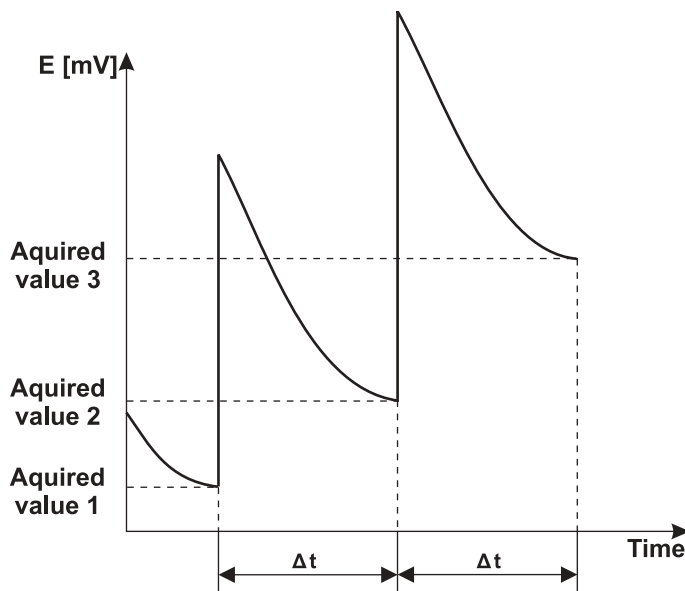

```
Timed Increment

Enter the period of time to wait until
the next dose.

      5 seconds

The range is from 2 to 180 seconds.

Accept  Escape  Delete
Digit
```

The range is from 2 to 180 seconds.

5.5.8 Electrode Type

Enter the type of the electrode, up to 24 characters. The electrode type will appear in the titration report.

Electrode Type

Select the highlighted letter by using the arrow keys then press "Enter".
 Select the empty field for a space.
 Press Accept to save the electrode type.

A	B	C	D	E	F	G	H	I	J	K	L	M
N	O	P	Q	R	S	T	U	V	W	X	Y	Z
a	b	c	d	e	f	g	h	i	j	k	l	m
n	o	p	q	r	s	t	u	v	w	x	y	z
0	1	2	3	4	5	6	7	8	9	()	/
_	.	@	^	-	,	<	=	>	+	*	%	/
ì	è	é	ò	à	ù	ç	ø	ö	õ	ä		
ä	i	ç	ñ	ñ	°	µ	'	#	!	\$	\	:

pH ████████████████████

Accept	Escape	Delete Letter	Cursor Left	Cursor Right
--------	--------	---------------	-------------	--------------

5.5.9 Blank Option

This feature allows the user to select the procedure for the blank calculations (where *V* is the volume of titrant dispensed during the titration and *Blank* is the volume of titrant consumed by the blank sample).

Blank Option

Select the option.

U - Blank

Blank - U

No Blank

Select	Escape			
--------	--------	--	--	--

METHODS

If one of the options (*V-Blank* or *Blank-V*) is selected in the **View / Modify Method** screen the *Blank Value* option will become active and the value of blank can be set (in liters).

Blank Value				
Enter the blank volume in liters.				
0.2580E-3 L				
Accept	Escape	Delete Digit		

5.5.10 Imposed Current (HI 902 only)

When **Fixed End Point (mV)** (see 5.5.4 End Point Mode) is set, the *Imposed Current* option will become available.

View / Modify Method				
Id: HIEN0201 Created: Jul 02, 2004 14:01				
Select the option to be modified.				
Name: Free Sulphur Dioxide				
Titration Type: Standard Titration				
Dosing Type: Dynamic				
End point Mode: Fixed 100.0 mV				
Pre-Titration Volume: 0.000 mL				
Pre-titration Stir Time: 10 Sec				
Measurement Mode: Signal Stability				
Electrode Type: Double Pt. electrode				
Blank Option: No Blank				
Imposed Current: 1 uA DC				
Calculations: Sample Calc. by Volume				
Titrant Name: Iodine				
Titrant Conc.: 1.0000E-2 M (mol/L)				
Analyte Size: 50.000 mL				
Select	Escape	Print Method	Page Up	Page Down

Using the imposed current feature in end point redox titrations has a great advantage on the speed of the redox reactions. The speed is increased significantly when the double Pt electrode used for the titration is polarized with a small imposed current (we obtain a steeper jump, perfect adapted for end point titrations).

In order to use this feature you must install the HI 900401 imposed current analog board.

The imposed current can be set from -100 μA to 100 μA with 1 μA resolution.

Imposed Current				
Enter the imposed current value in μA .				
1 μA				
Accept	Escape	Delete Digit		

5.5.11 Calculations

The titrator will make certain calculations in order to obtain the result of the analysis. The result is computed starting from the end point volume (titrant volume at the equivalence point), using a formula set by the user.

Calculations				
Select either the calculation to be performed or modify the variables.				
Edit Variable Values No Formula (mL only) Sample Calc. by Weight Sample Calc. by Volume Stdz. Titrant by Weight Stdz. Titrant by Volume Generic Formula				
Select	Escape			

5.5.11.1 Standard Titrations

Edit Variable Values

This option allows the user to change the values of the variables used in a previously selected calculation.

For each formula, selected variables can be changed.

No Formula (mL only)

If this option is selected, only delivered milliliters (mL) are displayed.

METHODS

Sample Calculations by Weight

This calculation should be used when the concentration of an analyte is determined in a solid sample. The results are based on the initial sample weight (in grams). When you choose this formula, select the *Titrant Unit* first and then the *Final Result Unit*.

Titrant Units					Final Result Units				
Select the titrant unit.					Select the unit for your results.				
<div style="border: 1px solid black; padding: 2px;">M (mol/L) N (eq/L) g/L mg/L</div>					<div style="border: 1px solid black; padding: 2px;">ppt (g/Kg) ppm (mg/Kg) ppb (µg/Kg) % = (g/100g) mg/g mg/Kg mol/Kg mmol/g eq/Kg meq/Kg</div>				
Select	Escape				Select	Escape			

The titrator will provide the results based on the titrant and sample units selected.

Titrant Units:

M (mol/L)	(moles/liter)
N (eq/L)	(equivalences/liter)
g/L	(grams/liter)
mg/L	(milligrams/liter)

Final Result Units:

ppt (g/Kg)	(parts per thousand; grams/kilogram)
ppm (mg/Kg)	(parts per million; milligrams/kilogram)
ppb (µg/Kg)	(parts per billion; micrograms/kilogram)
% = g/100 g	(percentage in weight; grams/100 grams)
mg/g	(milligrams/gram)
mg/Kg	(milligrams/kilogram)
mol/Kg	(moles/kilogram)
mmol/g	(millimoles/gram)
eq/Kg	(equivalences/kilogram)
meq/Kg	(milliequivalences/kilogram)

If the titrant unit is selected as M (mol/L) and the final sample unit as g/Kg (grams/kilogram) the formula used to generate the result is displayed below:

Calculating Sample Concentration

M (mol/L) --> ppt (g/Kg)

The calculation is:

$$\frac{U \times \frac{\text{mol}}{\text{L}} \times \frac{\text{mol}}{\text{mol}} \times \frac{\text{g}}{\text{mol}}}{\frac{\text{g}}{\text{kg}} \times 1000\text{g}}$$

Select the variables to change value.
U = volume dispensed in liters.

1.000 mol/L -> titrant conc.

1.000 mol/mol -> (sample/titrant)

1.000 g/mol -> mw of sample

1.000 g -> sample weight

Select	Escape	Save / Exit	
--------	--------	----------------	--

Some variables can be set according to the amount of sample and titrant used.

Sample Calculations by Volume

This calculation should be used when the concentration of an analyte is determined in a liquid sample. The results are based on the initial sample volume (in milliliters). When choosing the formula, select the *Titrant Unit* first and then the *Final Sample Unit*. The titrator will perform the calculation based on the titrant and the sample units selected.

Titrant Units

Select the titrant unit.

M (mol/L)

N (eq/L)

g/L

mg/L

Select	Escape		
--------	--------	--	--

Final Result Units

Select the unit for your results.

ppt (g/L)

ppm (mg/L)

ppb (µg/L)

M (mol/L)

N (eq/L)

g/L

mg/L

µg/L

mol/L

mmol/L

mg/mL

g/100 mL

eq/L

meq/L

Select	Escape		
--------	--------	--	--

Titrant Units:

- M (mol/L) (moles/liter)
- N (eq/L) (equivalences/liter)
- g/L (grams/liter)
- mg/L (milligrams/liter)

Final Sample Units:

- ppt (g/L) (parts per thousand; grams/liter)
- ppm (mg/L) (parts per million; milligrams/liter)
- ppb (µg/L) (parts per billion; micrograms/liter)

METHODS

M (mol/L)	(Molarity; moles/liter)
N (eq/L)	(Normality; equivalences/liter)
mg/L	(milligrams/liter)
µg/L	(micrograms/liter)
mmol/L	(millimoles/liter)
mg/mL	(milligrams/milliliter)
g/100 mL	(grams/100 milliliters)
eq/L	(equivalences/liter)
meq/L	(milliequivalences/liter)

If the titrant unit is selected as N (eq/L) and the final sample unit as g/L (grams/liter), the formula used to generate the result is displayed below.

```
Calculating Sample Concentration

N (eq/L) --> g/L

The calculation is:

$$\frac{U \times \frac{\text{eq}}{\text{L}} \times \frac{\text{mol}}{\text{eq}} \times \frac{\text{g}}{\text{mol}}}{\text{mL} \times \frac{\text{L}}{1000\text{mL}}}$$

Select the variables to change value.
U = volume dispensed in liters.

1.000 eq/L -> titrant conc.
1.000 mol/eq -> (sample/titrant)
1.000 g/mol -> mw of sample
1.000 mL -> sample volume

Select  Escape  Save / Exit
```

Some variables can be set according to the amount of sample and titrant used.

Standardize Titrant by Weight

This calculation should be used when the titrant is standardized (concentration determination) using a solid standard. Determination of the titrant concentration is based on the primary standard weight (in grams).

```
Titrant Units

Select the titrant unit.

M (mol/L)
N (eq/L)
g/L
mg/L

Select  Escape
```

The titrator will provide the calculation based on the titrant unit selected.

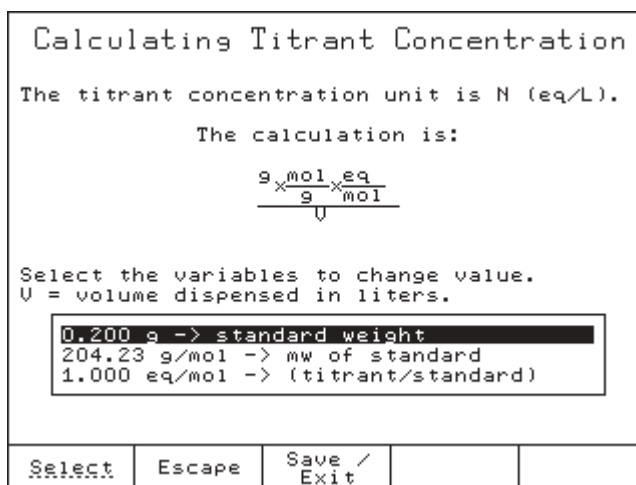

Standardize Titrant by Volume

This calculation should be used when the titrant is standardized (concentration determination) using a standard solution. Determination of the titrant concentration is based on the primary standard volume (in milliliters).

The titrator will perform the calculation based on the titrant unit selected.

Generic Formula

This option allows the user to define their own calculation formula of the final analyte concentration in a solid or liquid sample. The variables can be set to reach any final result from the list below:

- ppt (g/Kg) (parts per thousand; grams/kilogram)
- ppt (g/L) (parts per thousand; grams/liter)
- ppm (parts per million; milligrams/kilogram)
- ppm (mg/L) (parts per million; milligrams/liter)
- ppb (parts per billion; micrograms/kilogram)
- ppb (µg/L) (parts per billion; micrograms/liter)
- % = g/100 g (percentage in weight; grams/100 grams)
- M (mol/L) (Molarity; moles/liter)
- mg/g (milligrams/gram)
- N (eq/L) (Normality; equivalences/liter)
- mg/Kg (milligrams/kilogram)
- mg/L (milligrams/liter)
- mol/Kg (moles/kilogram)
- µg/L (micrograms/liter)
- mmol/g (millimoles/gram)
- eq/Kg (equivalences/kilogram)
- mmol/L (millimoles/liter)
- meq/Kg (milliequivalences/kilogram)
- mg/mL (milligrams/milliliter)
- g/100 mL (grams/100 milliliters)

METHODS

eq/L
meq/L

(equivalences/liter)
(milliequivalences/liter)

Final Result Units

Select the unit for your results.

% = (g/100g)

mg/g

mg/Kg

mol/Kg

mmol/g

eq/Kg

meq/Kg

ppt (g/L)

ppm (mg/L)

ppb (µg/L)

M (mol/L)

N (eq/L)

g/L

mg/L

Select	Escape	Page Up	Page Down
--------	--------	---------	-----------

The formula can be used either for titrant standardization or for sample analysis.

$$\frac{C \cdot V \cdot F1 \cdot F2 \cdot F3}{S}$$

Calculating Sample Concentration

Final unit is mg/L.

The calculation is:

$$\frac{C \times U \times F1 \times F2 \times F3}{S}$$

Select the variables to change value.
U = volume dispensed in liters.

1.000 C -> (titrant conc.)

1.000 F1 -> (general factor)

1.000 F2 -> (general factor)

1.000 F3 -> (general factor)

1.000 S -> (sample size)

Select	Escape	Save / Exit	
--------	--------	-------------	--

Where:

C = the concentration of the titrant

F1 = general factor

F2 = general factor

F3 = general factor

S = sample size, in grams or milliliters

V = the volume delivered, in liters, to reach the preset or equivalence end point (determined by the titrator)

Titrant Concentration:

The units for titrant concentration can be:

mol/L	(concentration unit of titrant)
eq/L	(concentration unit of titrant)
g/L	(concentration unit of titrant)
mg/L	(concentration unit of titrant)

One of the general factors should be used as a stoichiometric factor, the other as unit conversion factor and the third as weight conversion factor.

Chemical combination factor:

The chemical combination factor is the chemical combination ratio between the analyte and titrant or standard and titrant.

In the particular case that the combination ratio is expressed in moles, this factor is called the stoichiometric factor.

This factor can be one of the following:

mol/mol	(moles of sample/moles of titrant)
mol/eq	(moles of sample/equivalence of titrant)
eq/mol	(equivalences of sample/moles of titrant)
mol/mol	(moles of titrant/moles of standard)
eq/mol	(equivalences of titrant/moles of standard)

Examples: 2 moles of NaOH react with 1 mole of H₂SO₄

Unit Conversion factor:

Used to convert between various measurement units.

Examples: L/1000 → mL
g/1000 → mg

Weight Conversion factor:

Used to convert between weight measurement bases (Kg, g, mg, µg or mole, mmole).

Example: g → mol

5.5.11.2 Back Titrations (HI 902 only)

Calculations				
Select either the calculation to be performed or modify the variables.				
<div style="border: 1px solid black; padding: 2px;"> <p>Sample Calc. by Weight</p> <p>Sample Calc. by Volume</p> <p>Generic Formula</p> </div>				
Select	Escape			

Sample Calculations by Weight

When choosing this formula, select the titrant 1 unit, the titrant 2 unit and then the final result unit.

Titrant 1 Units				
Select the titrant 1 unit.				
<div style="border: 1px solid black; padding: 2px;"> <p>M (mol/L)</p> <p>N (eq/L)</p> <p>g/L</p> <p>mg/L</p> </div>				
Select	Escape			

Titrant 2 Units				
Select the titrant 2 unit.				
<div style="border: 1px solid black; padding: 2px;"> <p>M (mol/L)</p> <p>N (eq/L)</p> <p>g/L</p> <p>mg/L</p> </div>				
Select	Escape			

Final Result Units				
Select the unit for your results.				
<div style="border: 1px solid black; padding: 2px;"> <p>ppt (g/Kg)</p> <p>ppm (mg/Kg)</p> <p>ppb (µg/Kg)</p> <p>% = (g/100g)</p> <p>mg/g</p> <p>mg/Kg</p> <p>mol/Kg</p> <p>mmol/g</p> <p>eq/Kg</p> <p>meq/Kg</p> </div>				
Select	Escape			

If the titrant 1 unit is selected as M (mol/L), titrant 2 unit is selected as M (mol/L) and the final result unit as mg/g (milligrams/gram) the following formula is used to calculate the amount of titrant 1 (used in the first stage of back titration or direct titration) and will be as follows:

Calc. Direct Titr. Volume

Titr1 Unit: M (mol/L)-->Result Unit: L

The calculation is:

$$\frac{g \times \frac{mol}{g} \times f}{\frac{mol}{L} \times \frac{mol}{mol}}$$

Select the variables to change value.

1.000 g -> sample weight

1.000 g/mol -> mw of sample

1.000 f ->(excess factor)

1.000 mol/L -> titrant 1 conc.

1.000 mol/mol -> (sample/titrant 1)

Select	Escape	Next	
--------	--------	------	--

The formula is based on an approximation: the sample concentration is 100% w/w. With this approximation, the titrator will calculate the volume of titrant 1 needed to consume the sample and multiply it with an excess factor in order to raise or to lower the amount of titrant 1 dispensed.

Some variables can be set according to the amount of sample and titrant 1 used.

When the parameters from the formula are set, press Next to proceed with the next formula used in the back titration algorithm.

If you do not want to use the "Calc. Direct Titr. Volume" formula, then from the **View / Modify Method** screen:

- highlight the *Titrant 1 Entry* option, press Select.
- highlight *Fixed Weight or Volume* option and press Select, you will be prompted to type the volume of titrant 1 to be dispensed in the first stage of back titration.

This formula is used to calculate the remaining volume of titrant 1 after the reaction with the sample.

Titrant 1 Entry

Select the type of titrant 1 entry.

Calculated By Formula

Fixed By User

Select	Escape		
--------	--------	--	--

METHODS

In order to calculate this volume, the remaining titrant 1 volume is titrated (pH/mV equivalence point titration) with titrant 2.

After the excess volume of titrant 1 is calculated, the following formula is used to calculate the exact volume of titrant 1 that was consumed by the sample:

$$V1 = V1_{tot} - V1_{excess}$$

When all the parameters are set, press to proceed with the "Calculating Sample Concentration" formula:

```
Calculating Sample Concentration

Final unit is mg/g:
The calculation is:
      U1 x mol x mol
      L x mol
      -----
      g x mol x g
      g x 1000mg

Select the variables to change value.
U1 = volume dispensed in liters

1.000 mol/L -> titrant1 conc.
1.000 mol/mol -> (sample/titrant1)
1.000 g -> sample weight
1.000 g/mol -> mw of sample
```

Select	Escape	Save / Exit		
--------	--------	----------------	--	--

Sample Calculations by Volume

When choosing formula, follow these steps:

```
Titrant 1 Units

Select the titrant 1 unit.

M (mol/L)
N (eq/L)
g/L
mg/L
```

Select	Escape			
--------	--------	--	--	--

← First select the titrant 1 unit

Titrant 2 Units

Select the titrant 2 unit.

M (mol/L)

N (eq/L)

g/L

mg/L

Select	Escape		
--------	--------	--	--

← Select the titrant 2 unit

Final Result Units

Select the unit for your results.

ppt (g/L)

ppm (mg/L)

ppb (µg/L)

M (mol/L)

N (eq/L)

g/L

mg/L

µg/L

mol/L

mmol/L

mg/mL

g/100 mL

eq/L

meq/L

Select	Escape		
--------	--------	--	--

← Select the final result unit

The titrator will provide the calculation based on the titrants and sample units selected. After you have selected the titrant 1, titrant 2 and the final result units the titrator will display a screen with a formula used to calculate the amount of titrant 1 (used in the first stage of back titration).

Calc. Direct Titr. Volume

Titr1 Unit: M (mol/L)-->Result Unit: L

The calculation is:

$$\frac{\text{mL} \times \frac{\text{L}}{1000\text{mL}} \times \frac{\text{g}}{\text{L}} \times \frac{\text{mol}}{\text{g}} \times f}{\frac{\text{mol}}{\text{L}} \times \frac{\text{mol}}{\text{mol}}}$$

Select the variables to change value.

1.000 mL -> sample volume

1.000 g/L -> sample max conc.

1.000 g/mol -> mw of sample

1.000 f ->(excess factor)

1.000 mol/L -> titrant1 conc.

Select	Escape		Next
--------	--------	--	------

METHODS

This calculation formula is used as an approximation of the sample concentration (sample max conc.). This formula can be used when we have an expected sample concentration (eg. we know that the sample concentration must be around 1 M (mol/L)).

If we don't have an expected sample concentration, then from the **View/Modify Method** screen:

- highlight the *Titrant 1 Entry* option, by pressing .
- highlight *Fixed By User* option and press , you will be prompted to type the volume of titrant 1 to be dispensed in the first stage of the back titration.

With this approximation, the titrator will calculate the volume of titrant 1 needed to consume the sample and multiply it by an excess factor in order to raise or to lower the amount of titrant 1 dispensed.

When the parameters from the formula are set, press to proceed to the next formula used in the back titration algorithm.

This formula is used to calculate the remaining volume of titrant 1 after the reaction with the sample.

Calc. Excess Volume Of Titr1.

M (mol/L) + M (mol/L) --> L

The calculation is:

$$\frac{V2 \times \frac{\text{mol}}{\text{L}} \times \frac{\text{mol}}{\text{mol}}}{\frac{\text{mol}}{\text{L}}}$$

U1 = V1tot - U1 excess
Select the variables to change value.
U2 = backtitr. vol. dispensed in liters.

1.000 mol/L -> titrant2 conc.
1.000 mol/mol -> (titrant1/titrant2)
1.000 mol/L -> titrant1 conc.

Select	Escape	Next	
--------	--------	------	--

In order to calculate this volume, the remaining volume of titrant 1 is titrated (pH/mV equivalence point titration) with the titrant 2.

After the excess (remaining) volume of titrant 1 is calculated, the following formula is used to calculate the exact volume of titrant 1 that was consumed by the sample:

$$V1 = V1_{tot} - V1_{excess}$$

When all the parameters are set, press Next to proceed with the "Calculating Sample Concentration" formula:

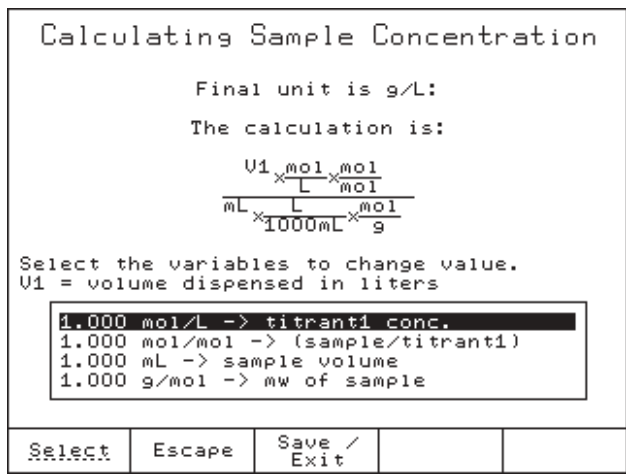

Generic Formula

This option allows the user to define their calculation formula for the "Direct Titration Volume", "Calculating Excess Volume of Titrant 1" and "Final Sample Concentration" in a solid or liquid sample.

5.5.12 Dilution Option

This option enables the dilution calculations to be made (when the initial sample is diluted, the titration is made with an aliquot of the diluted sample). The calculations are made for the sample weight (volume) in order to express the results for the initial sample.

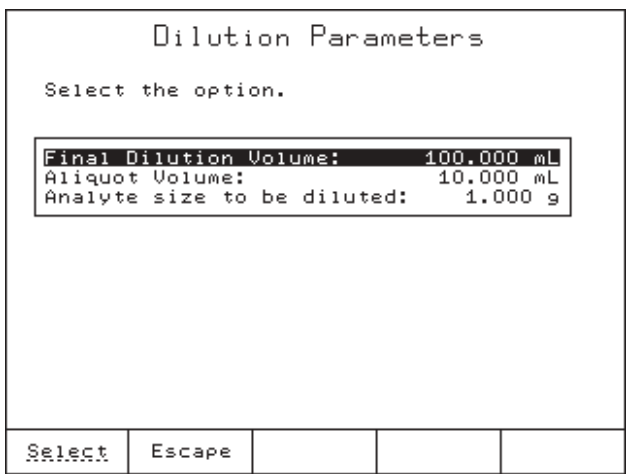

Final Dilution Volume: The volume of the sample after the dilution process.

Aliquot Volume: The volume of the aliquot (sample volume used for the titration)

Analyte size to be diluted: The initial sample weight (volume)

METHODS

The sample size used in the calculations will be:

$$\frac{\text{Analyte size to be diluted} * \text{Aliquot Volume}}{\text{Final Dilution Volume}}$$

5.5.13 Titrant Name

Enter the name of the titrant (up to 24 characters). This name will appear in the titration report.

Titrant Name

Select the highlighted letter by using the arrow keys then press "Enter". Select the empty field for a space. Press Accept to save the titrant name.

A	B	C	D	E	F	G	H	I	J	K	L	M
N	O	P	Q	R	S	T	U	V	W	X	Y	Z
a	b	c	d	e	f	g	h	i	j	k	l	m
n	o	p	q	r	s	t	u	v	w	x	y	z
0	1	2	3	4	5	6	7	8	9	()	/
-	.	%	^	_	,	<	=	>	+	*	%	\
	è	é	ò	à	ù	ç	ß	ü	ö	ö	ä	:
ã	i	ç	ñ	ñ	°	µ	'	#	!	\$	\	:

■ NEOH

Accept	Escape	Delete Letter	Cursor Left	Cursor Right
--------	--------	---------------	-------------	--------------

5.5.14 Titrant Concentration

Enter the concentration of the titrant to be used. When determining the titrant concentration only the unit is displayed and the titrant concentration can not be set.

5.5.15 Analyte Size

Enter the size of the sample (for sample concentration determinations) or standard (for titrant concentration determination).

5.5.16 Analyte Entry

With this option select the entry type mode of the analyte.

Analyte Entry

Select the entry mode of analyte.

Fixed Weight or Volume

Manual Weight or Volume

Verify the correct formula is being used, I.E. weight or volume analyte type.

Select	Escape			
--------	--------	--	--	--

5.5.16.1 Fixed Weight or Volume

Each titration will use the same analyte weight or volume as preset in the calculations.

5.5.16.2 Manual Weight or Volume

Each titration will use a different analyte weight or volume. The titrator will prompt for the analyte volume at the beginning of each titration.

5.5.17 Titrant 1 Entry (HI 902 only)

Select the mode for evaluating the necessary quantity of titrant 1 used in the back titration process (phase 1).

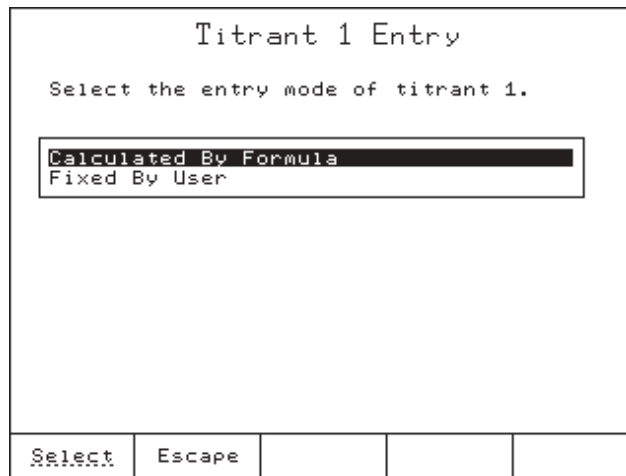

5.5.17.1 Calculated by Formula

The volume of titrant 1 to be dispensed in the phase 1 of back titration will be calculated by formula (see *Calc. Direct Titr. Volume* screen on page 5-35).

5.5.17.2 Fixed by User

Fixed volume of titrant 1 will be used during the first phase of back titration process (direct titration).

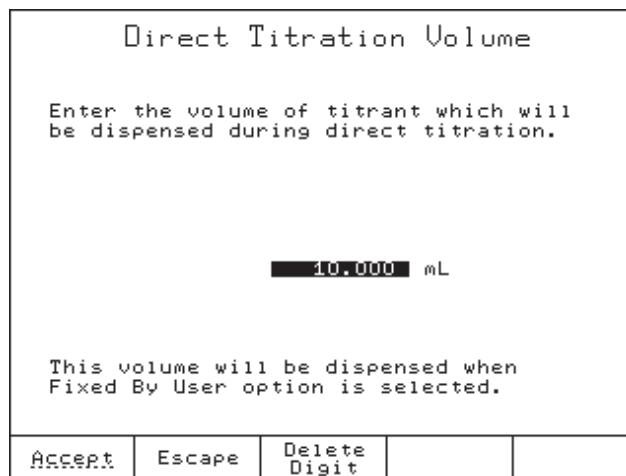

5.5.18 Maximum Titrant Volume

The maximum titrant volume used in the titration must be set according to the analysis. If the titration end point (fixed or equivalence End Point) is not reached, the titration will be abnormally terminated after the maximum titrant volume has been dispensed. The error message ("Limits Exceeded") will appear on the display.

Maximum Titrant 2 Volume				
Enter the maximum titrant volume to be dispensed.				
25.000 mL				
Recommend the total volume of the burette.				
Accept	Escape	Delete Digit		

Range is from 0.100 to 100.000 mL.

5.5.19 Stirring Speed

The stirring speed can be set between 100 and 2500 RPM with 100 RPM resolution.

Stirring Speed				
Enter the speed of the stirrer during the titration.				
1000 RPM				
The range is from 100 to 2500 RPM.				
Accept	Escape	Delete Digit		

The preset value of stirrer speed from the current method is used during the entire process, as long as the method is set as active.

Also, the speed can be adjusted using the \triangle and ∇ keys when the stirrer is on.

5.5.20 Potential Range

The allowable input potential range can be set by the user. Outside of these limits, if the titration is in progress, the titration will be abnormally terminated and an error message will appear.

These limits provide protection against a titration that does not generate an end point due to potential over-range.

Potential Range				
Enter the upper and lower potential.				
2000.0 mV - Upper Limit				
-2000.0 mV - Lower Limit				
Press Next to move to the next entry.				
Accept	Escape	Delete Digit	Next	

The ranges must be set within -2000.0 to 2000.0 mV.

5.5.21 Volume/Flow Rate

The flow rate for the dosing system can be set by the user in an interval of 0.1 to twice the total burette volume, as follows:

- 0.1 to 10 mL/min for a 5 mL burette
- 0.1 to 20 mL/min for a 10 mL burette
- 0.1 to 50 mL/min for a 25 mL burette
- 0.1 to 100 mL/min for a 50 mL burette

Flow Rate				
Enter the titrant flow rate.				
50.0 mL/min				
The range is from 0.1 to twice the total volume of the burette.				
Accept	Escape	Delete Digit		

Note: The titrator automatically detects and displays the burette size. The flow rate is set for all burette operations.

5.5.22 Signal Averaging

This option enables or disables a filtering on the mV/pH reading.

If *1 Reading* is selected, the filtering is disabled. Otherwise, the titrator will take the last reading and place it into a "moving window" along with the last 2, 3 or 4 readings (depending on the selected option). The average of those readings is displayed and used for calculations.

Signal Averaging

Select the number of readings to be averaged.

1 Reading
2 Readings
3 Readings
4 Readings

Select	Escape			
--------	--------	--	--	--

Averaging more readings is helpful when a noisy signal is received from the electrode.

5.6 Printing

To print method parameters, press Method Options from the main screen.

Press Print Method and wait a few seconds until the printer completes the job.

If no printer is connected to the dedicated socket, or if the printer is offline, an error message will appear on the display (see *9.3.3 Connecting a Printer* section, for information about connecting a printer to the titrator).

Chapter 6. Contents

- 6 TITRATION MODE 6 - 3**
- 6.1 Titration Start 6 - 3**
 - 6.1.1 In Progress Titration 6 - 3
 - 6.1.2 Suspend Titration 6 - 3
 - 6.1.3 On-line Graph 6 - 3
- 6.2 Titration Stop 6 - 5**

6 TITRATION MODE

6.1 Titration Start

Before beginning to perform a titration make sure that the following conditions are met:

- A pump is properly installed and selected as active.
- A burette is inserted in the pump and filled with titrant.
- The aspiration tube is inserted in the titrant bottle and the dispensing tube is over the analyte beaker.
- The electrode and the temperature probe is inserted in the analyte beaker.
- The desired method is selected as active and the parameters are set at optimum values.

6.1.1 In Progress Titration

To start a new titration, press  from the main screen.

When a titration begins:

- The stirrer will turn on (if detected and enabled).
- If the pre-stirring time option is enabled, the sample will be stirred until the prescribed time elapses (see *5.5.6 Pre-Titration Stir Time*).
- If the pre-titration volume option is enabled, the prescribed volume will be dispensed (see *5.5.5 Pre-Titration Volume*).
- According to the *Measurement Mode* and the *Dosing Type* option, the titrator will start to deliver doses until the titration end point are detected or a titration stop condition occurs.

6.1.2 Suspend Titration

While titration is in progress, you can temporarily stop it by pressing . All the titration parameters will be frozen.

You can continue the titration by pressing .

6.1.3 On-line Graph

During a titration, both the potentiometric S-shaped curve and the selected derivative curve (titration with equivalence point only) can be displayed on the **Titration Graph** screen, by pressing . The titration ID report is also displayed inside the graph window.

TITRATION MODE

The S-shaped curve and the derivative curve are scaled to fit simultaneously inside the display. Also, when the titration is normally terminated (end point detected successfully), the end point volume value marked with a cross is displayed on the graph.

The contents of the graph as related to an end point type, is as follows:

Equivalence End Point (pH) - the pH curve and the selected derivative vs volume is displayed. (see Figure 1)

Equivalence End Point (mV) - the mV curve and the selected derivative vs volume is displayed. (see Figure 2)

Fixed End Point (pH) - only the pH vs volume curve is displayed. (see Figure 3)

Fixed End Point (mV) - only the mV vs volume curve is displayed. (see Figure 4)

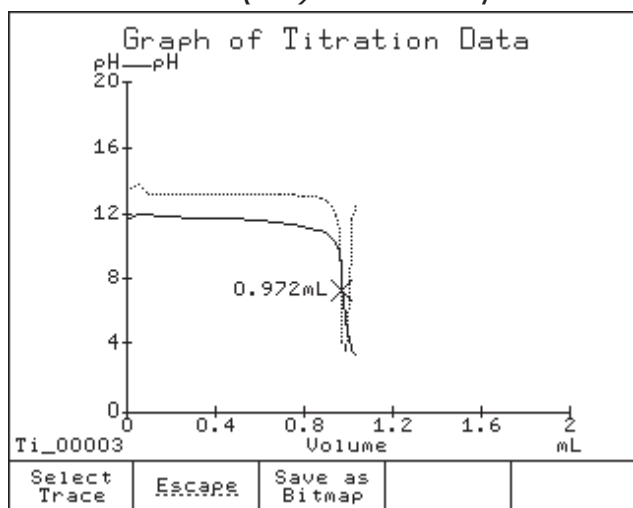

Figure 1

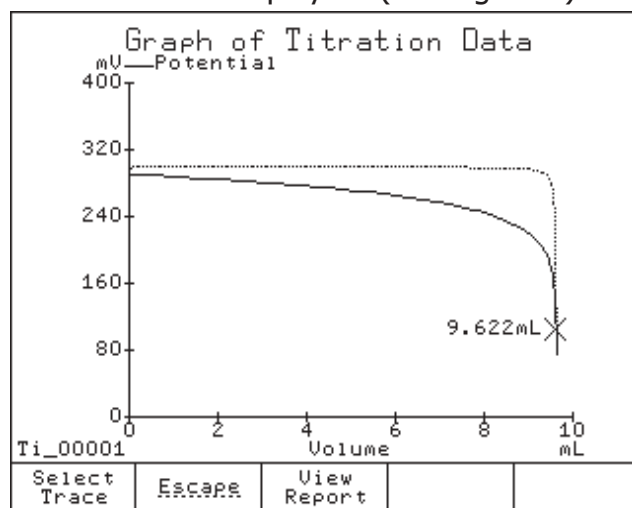

Figure 2

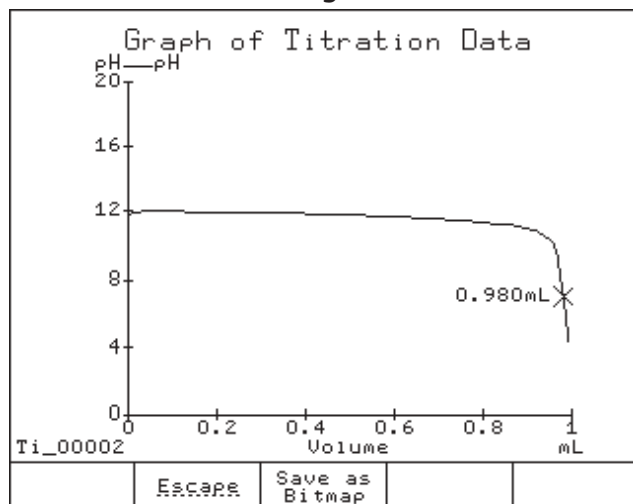

Figure 3

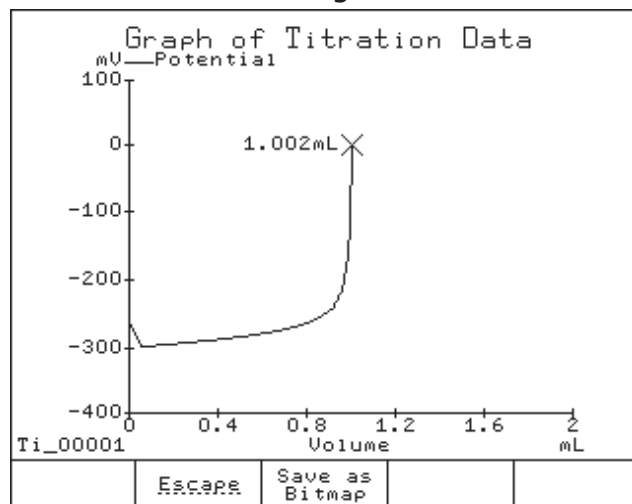

Figure 4

Select Trace - allows you to view on the ordinate axis a plot of either the mV (or pH) values or the selected derivatives values (of mV or pH). Available only for titrations with equivalence end points.

 Save as
Bitmap

- allows you to save the graph as a bitmap file. Available only when the titration is finished (after end point detection).

6.2 Titration Stop

The titration can be finished in one of the modes described below:

- **Titration Completed.** The titration was successfully terminated (with end point successfully detected). This is the only mode with valid final result values.
- **Manually Terminated.** The current titration was manually terminated before end point detection was achieved.
- **Limits Exceeded.** The preset maximum titrant volume was delivered without reaching the end point. The titration is stopped with an error message.
- **Critical Error.** A critical error occurred and the titration was stopped. These errors are normally related to the dosing system. The titration is stopped with a specific error message.
- **Potential Out of Range.** The measured values from the input sensor are outside the preset range (potential range). The titration is stopped with an error message.

Chapter 7. Contents

7	pH & mV MODE	7 - 3
7.1	pH Mode	7 - 3
7.1.1	Display	7 - 3
7.1.2	pH Menu	7 - 4
7.1.2.1	Add a Buffer (Auto-Entry)	7 - 4
7.1.2.2	Add a Buffer (Manual-Entry)	7 - 4
7.1.2.3	Clear Standardization	7 - 5
7.1.2.4	Edit Buffer Set	7 - 5
7.1.2.5	Graph Standardization Data	7 - 6
7.1.2.6	pH Standardization Data	7 - 6
7.1.2.7	Resolution	7 - 6
7.2	mV Mode	7 - 6
7.2.1	Display	7 - 6
7.2.2	mV Menu	7 - 7
7.2.2.1	Auto-Zero Relative mV	7 - 7
7.2.2.2	Enter a Manual Relative mV	7 - 7
7.2.3.1	Clear Relative mV Offset	7 - 8
7.3	Logging	7 - 8
7.3.1	Automatic Logging	7 - 9
7.3.2	Manual Logging	7 - 9

7 pH & mV MODE

The HI 901 / HI 902 titrators can be used to log precise pH or mV measurements.

By pressing pH/mV from the main screen, the titrator will switch to the **pH** or **mV** screen (depending on the *End Point Mode* option selected from **View / Modify Method** screen).

7.1 pH Mode

7.1.1 Display

The **pH** screen shown below will help you understand the following explanations.

pH Mode Option keys:

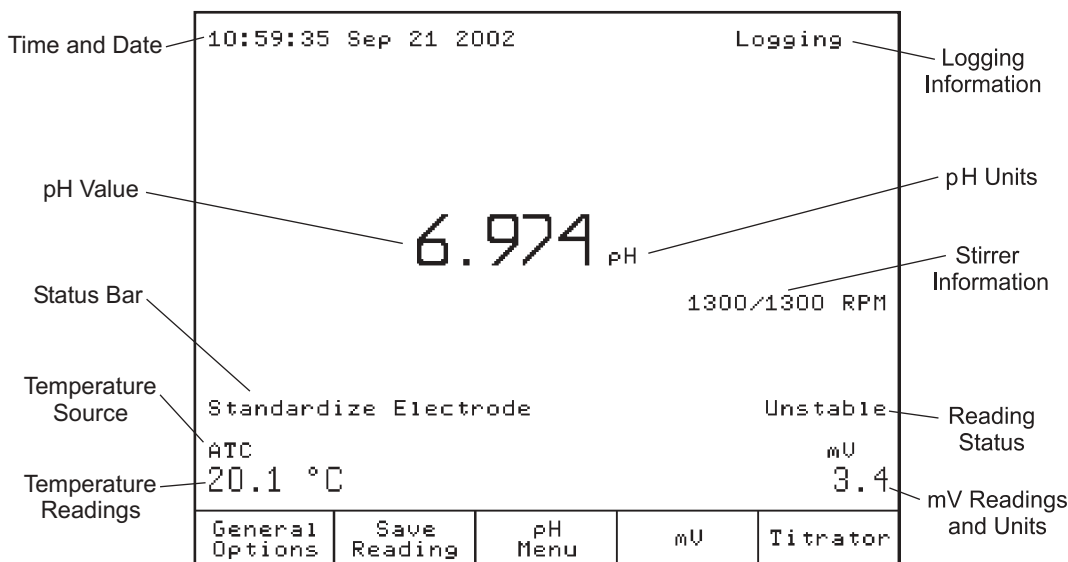

General Options

Brings you to the **General Options** screen (for more details, see Chapter 4 *General Options*).

Save Reading

Stores the current pH reading (see section 7.3.2 *Manual logging*).

pH Menu

Displays the setup options for pH (see section 7.1.2 *pH Menu*).

mV

Switches to the **mV** screen.

Titrator

Return to the main screen.

7.1.2 pH Menu

Options from this screen (except the *Resolution* option) refer to the pH electrode calibration functions.

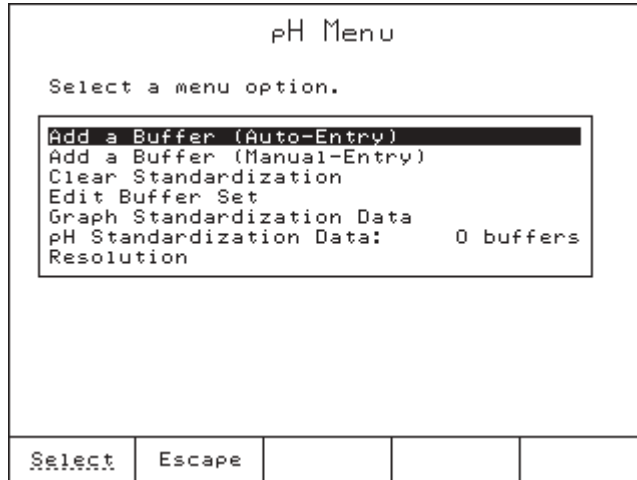

7.1.2.1 Add a Buffer (Auto-Entry)

Add a new buffer (up to 5 buffers can be added) or replace an existing one from the electrode standardization table. The buffer is now automatically recognized and temperature compensated from the created buffer list (see section *7.1.2.4 Edit Buffer Set*).

The titrator accepts electrode's slope between 80 to 105%.

7.1.2.2 Add a Buffer (Manual-Entry)

The user can add a custom buffer to the calibration list. The titrator will prompt for the custom buffer value. The buffer value entered should be correlated with the expected temperature value. The range is from -2.000 to 20.000 pH.

The titrator accepts electrode's slope between 80 to 105%.

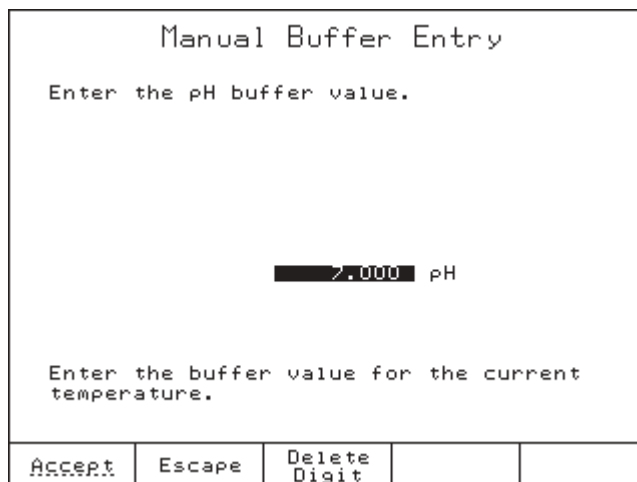

7.1.2.3 Clear Standardization

Deletes electrode standardization. The titrator will prompt for confirmation.

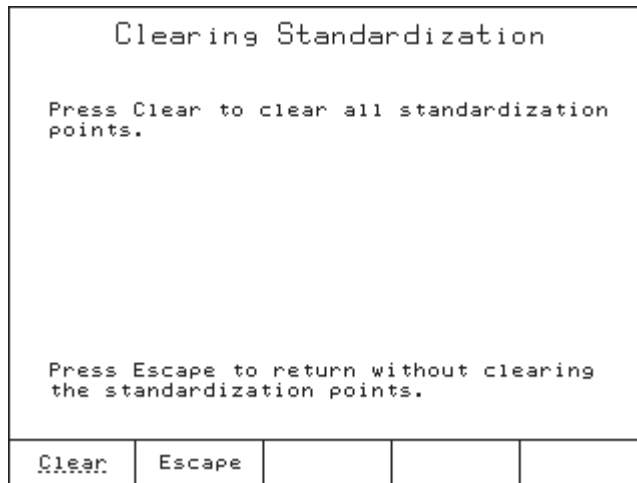

7.1.2.4 Edit Buffer Set

Creates a unique, auto-recognized buffer set. The new calibration standard buffer will be checked from the set described below.

Available buffers include:

- Hanna:** 4.01, 6.86, 7.01, 9.18, 10.01
- CRC:** 1.68, 3.56, 4.01, 6.87, 7.41, 9.18, 12.46
- DIN:** 1.09, 3.06, 4.65, 6.79, 9.23, 12.75
- NIST:** 4.01, 6.86, 7.42

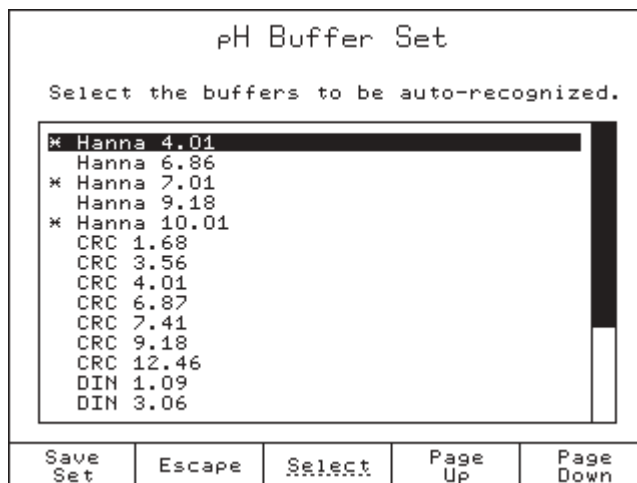

To select a buffer from the list, highlight the desired buffer and press Select to add it to the buffer set. The selected buffers are marked with an asterisk.

Note: Although any combination of buffers may be selected, their values should be at least 1.5 pH units apart.

pH & mV MODE

7.1.2.5 Graph Standardization Data

Graphs the electrode standardization data (pH vs mV).

7.1.2.6 pH Standardization Data

Displays the electrode standardization data in a tabular form.

7.1.2.7 Resolution

You can choose between 0.1, 0.01 and 0.001 resolution for the displaying pH values.

7.2 mV Mode

7.2.1 Display

The *mV* screen shown below will help you understand the following discussion.

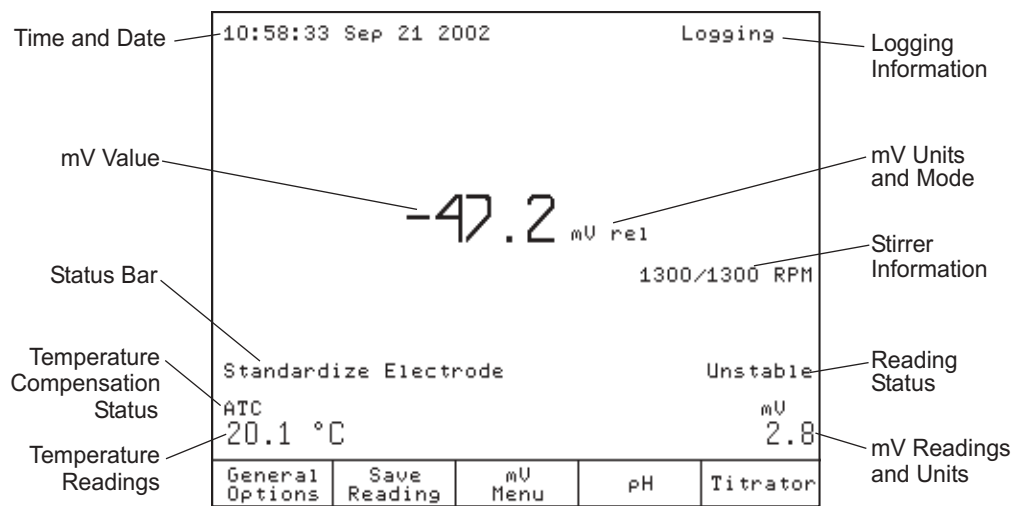

mV Mode Option Keys:

- General Options**: Brings you to the **General Options** screen (for more details, see Chapter 4 *General Options*).
- Save Reading**: Stores the current mV reading (see section 7.3.2 *Manual logging*).
- mV Menu**: Displays the setup options for mV (see section 7.2.2 *mV Menu*).
- pH**: Switches to the **pH** screen.
- Titration**: Return to the main screen.

7.2.2 mV Menu

By pressing , the following screen will be displayed:

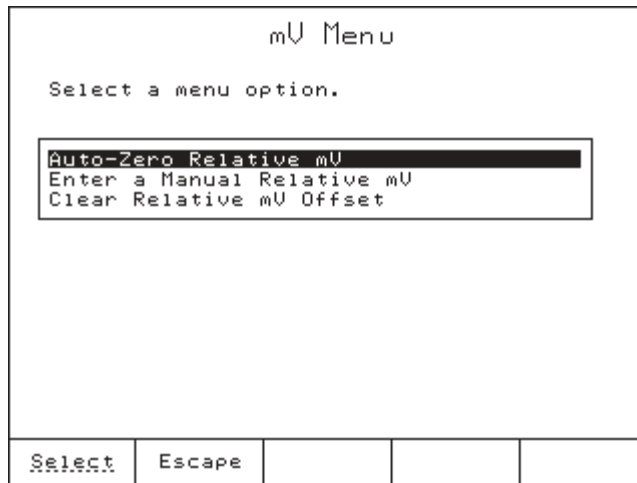

7.2.2.1 Auto-Zero Relative mV

This sets the relative potential to zero by saving the current potential and subtracting it from subsequent readings.

If an absolute zero is needed, replace the electrode with a shorting cap before performing this action.

Note: The auto-zero will affect the mV reading and therefore the pH value (new displayed relative mV reading will be used to calculate the new pH value).

7.2.2.2 Enter a Manual Relative mV

Allows to enter the mV offset . The range is from -2000.0 to 2000.0 mV.

The set value is subtracted from the actual readings from electrode.

In this case, the actual readings are displayed in the mV readings field and "rel" icon is displayed near the mV units.

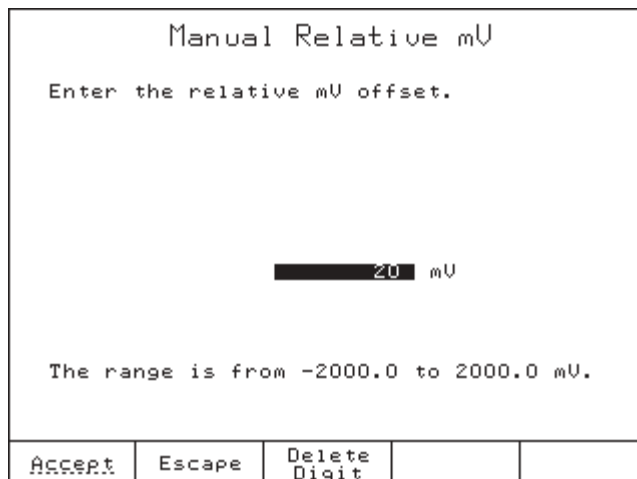

7.2.2.3 Clear Relative mV Offset

Sets the mV offset to zero. With this option, the previous relative value or auto zero is cleared.

7.3 Logging

When in pH or mV mode, logging can be either manual or automatic.

Before starting an automatic or manual logging operation, please customize a unique report for the saved pH and mV measurements, as follows:

- From the *pH* or *mV* screen, press to display the **Data Parameters** screen.
- Highlight the *Setup pH/mV Report* option and press to display the **Setup pH/mV Report** screen.

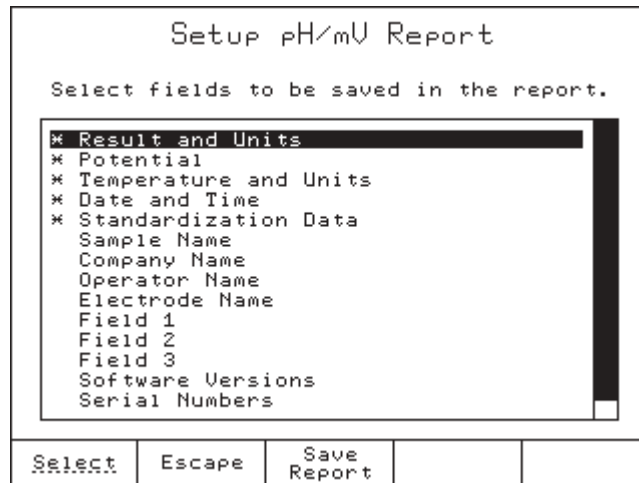

- Use the and keys to highlight the data field that you want to show/hide in the pH/mV report and then press to activate/deactivate it.
- Each field marked by "*" is an active field selected for the report.
- Press to save the customized report.

7.3.1 Automatic Logging

To start automatic logging pH or mV readings, follow these steps:

- From the *pH* or *mV* screen, press **results** to display the *Data Parameters* screen.
- Highlight the *Logging Interval – pH/mV* option and press **Select** to display the *Logging Interval* screen.

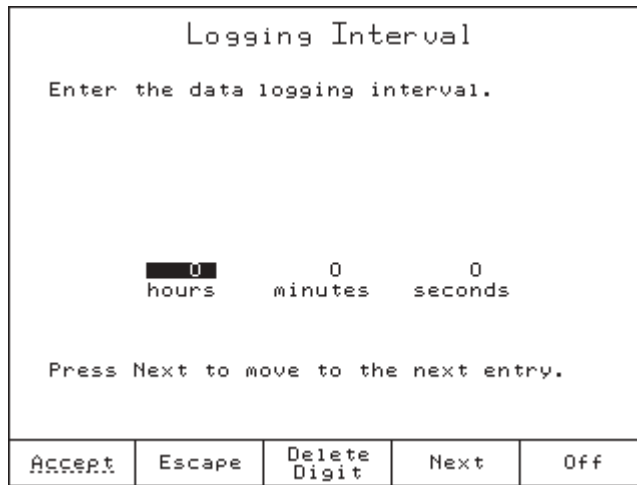

- Enter the time interval between each consecutive record.
The time between records can be set in the following range:
Hours 0 to 8
Minutes 0 to 59
Seconds 0 to 59
- Press **Accept** and then **Escape** to save the setting and return to the *pH* or *mV* screen.
- Press **start/stop** to start auto-logging.

The logging interval and name of logging file will be also displayed on the *pH* or *mV* screen. To stop the automatic logging, press **start/stop** again.

7.3.2 Manual Logging

To manually log pH or mV readings, press **Save Reading** from the *pH* or *mV* screen. A new record will be added to the logging file every time **Save Reading** is pressed.

Chapter 8. Contents

8	AUXILIARY FUNCTIONS	8 - 3
8.1	Burette	8 - 3
8.1.1	Prime Burette	8 - 3
8.1.2	Rinse Tip	8 - 4
8.1.3	Manual Dispense	8 - 4
8.1.4	Purge Burette	8 - 5
8.2	Stirrer	8 - 5
8.3	Results	8 - 6
8.3.1	Review Last Titration Report	8 - 6
8.3.2	Review Available Reports	8 - 6
8.3.3	GLP Data	8 - 7
8.3.4	Instrumentation Data	8 - 8
8.3.5	Logging Interval – pH/mV	8 - 9
8.3.6	Setup pH/mV Report	8 - 9
8.3.7	Setup Titration Report	8 - 9

8 AUXILIARY FUNCTIONS

8.1 Burette

To access the **Burette** screen, press Burette from the main screen. Highlight the desired option and then press Select.

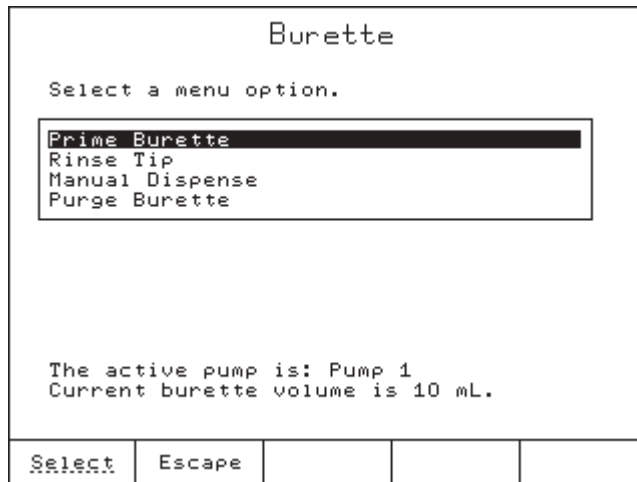

8.1.1 Prime Burette

The *Prime Burette* option is used to mechanically fill the burette before starting a set of analysis.

Two rinses cycles of burette are shown in the figure below. The dispensing tube is connected on the right side and the aspiration tube on the left side.

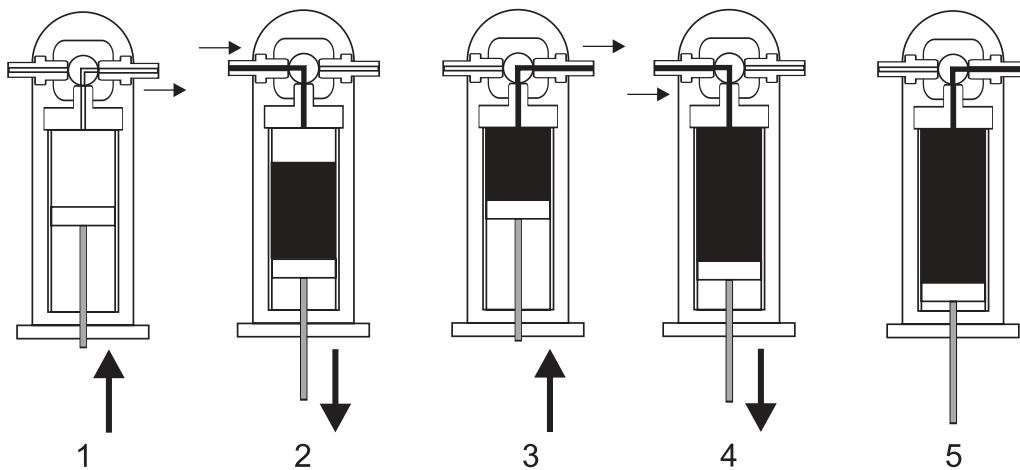

Note: Before starting this operation, the aspiration tube must be inserted in the titrant bottle.

AUXILIARY FUNCTIONS

To prime the burette, select *Prime Burette* from the **Burette** screen. Enter the number of rinses and press .

Total Burette Rinses				
Enter the total number of burette rinses.				
3				
A minimum of three rinses is recommended.				
Accept	Escape	Delete Digit		

The number of burette rinses can be set between 1 and 5 (we recommend at least three rinses to assure that the air bubbles are completely removed).

8.1.2 Rinse Tip

A 2 mL dose of titrant will be dispensed from the burette when this operation is started. This operation will eliminate the air from the dispensing tip.

8.1.3 Manual Dispense

Using the *Manual Dispense* option, a defined titrant volume can be dosed. Select the *Manual Dispense* option and press . The **Manual Volume Dispense** screen will become active and the display will prompt you to enter the desired volume to be dispensed.

Manual Volume Dispense				
Enter the amount of volume to be dispensed.				
1.000 mL				
Current burette volume is 10 mL.				
Accept	Escape	Delete Digit		

The manual dispense volume must be between the limits shown bellow:

- 0.001 to 4.500 mL for a 5 mL burette
- 0.001 to 9.000 mL for a 10 mL burette
- 0.005 to 22.500 mL for a 25 mL burette
- 0.005 to 45.000 mL for a 50 mL burette

8.1.4 Purge Burette

This option allows titrant evacuation before cleaning and/or storing the burette. The burette is flushed twice.

Note: Before starting this operation, remove the aspiration tube from the titrant bottle.

The figures below show the steps in a purge burette operation.

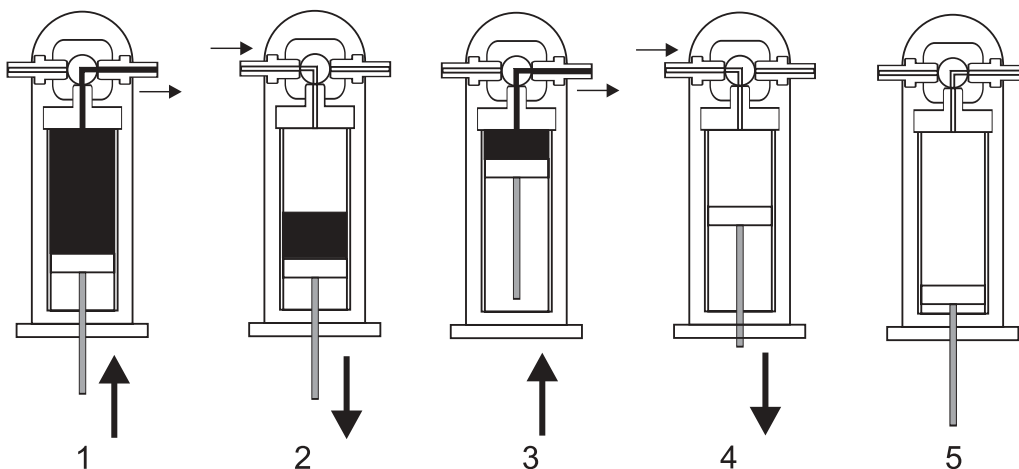

8.2 Stirrer

The stirrer can be started and stopped by pressing .

The stirring speed is set within the active methods (see section 5.5.17 *Stirring Speed*).

During the process, the stirring speed can also be manually adjusted by using the \triangle and ∇ keys.

AUXILIARY FUNCTIONS

8.3 Results

The **Data Parameters** screen contains options regarding data parameters from the titrator, as follows:

Data Parameters											
Select a menu option.											
<table border="1"><tr><td>Review Last Titration Report</td></tr><tr><td>Review Available Reports</td></tr><tr><td>GLP Data</td></tr><tr><td>Instrumentation Data</td></tr><tr><td>Logging Interval - pH/mV</td></tr><tr><td>Setup pH/mV Report</td></tr><tr><td>Setup Titration Report</td></tr></table>					Review Last Titration Report	Review Available Reports	GLP Data	Instrumentation Data	Logging Interval - pH/mV	Setup pH/mV Report	Setup Titration Report
Review Last Titration Report											
Review Available Reports											
GLP Data											
Instrumentation Data											
Logging Interval - pH/mV											
Setup pH/mV Report											
Setup Titration Report											
Select	Escape										

8.3.1 Review Last Titration Report

Selecting this option, the last titration data can be reviewed.

The last titration report file can be displayed or printed. Also, the titration graph can be reviewed by selecting View Graph.

Review Result				
Titration Report				
Method Name:	NaOH Titrant Conc.			
Time & Date:	13:04 May 12, 2004			
Titration ID:	Ti_00002			
Titration Results				
Method Name:	NaOH Titrant Conc.			
Time & Date:	13:04 May 12, 2004			
Analyte Size:	4.000 g			
Titration Duration:	0:08 [mm:ss]			
Titration was Manually Terminated				
Operator Name:				
View Graph	Escape	Print Report	Page Up	Page Down

The information that can be reviewed in the report is based on the selections made in the **Setup Titration Report** screen.

The following option keys are available:

View Graph Allows review of the last performed titration graph. The pH (or mV) versus titrant volume curve can also be displayed. Also, if the *Equivalence End Point* option was selected, the pH (or mV) curve and selected derivative curve (1st derivative, 2nd derivative) versus titrant volume are simultaneously displayed. Pressing Select Trace will change the vertical axes scale units.

Print Report Allows printing the report to the printer.

8.3.2 Review Available Reports

Up to 100 reports can be recorded on the titrator. To view one of the recorded reports highlight a report and then press .

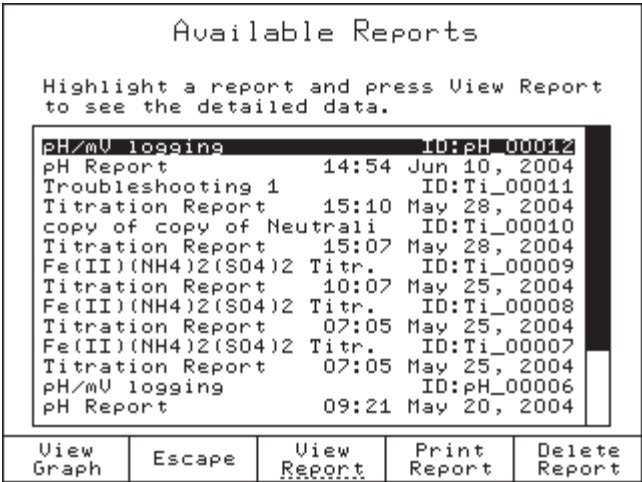

All the reports stored in the titrator (titration and pH/mV reports) can be reviewed and printed. The report contains only the information selected in the **Setup Titration Report** and **Setup pH/mV Report** screens during report configuration.

The keys are the same as in the previous section (8.3.1 Review Last Titration Report).

 Allows you to delete the selected report.

8.3.3 GLP Data

Enter up to 20 alphanumeric characters for each option from **GLP Data** screen.

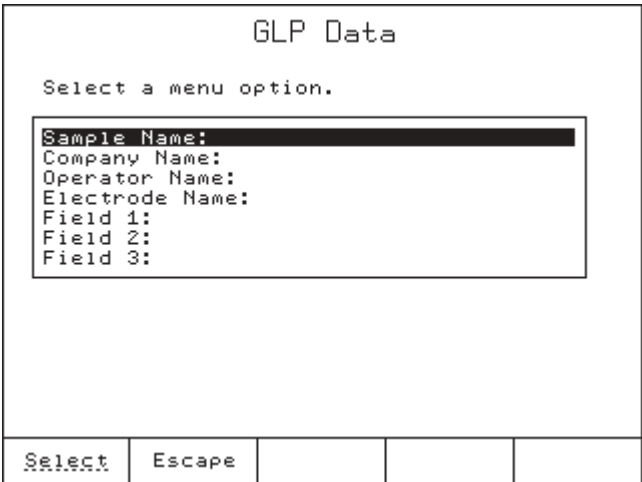

Sample Name - Allows the sample name to be recorded in each report. The sample name will increase by one, with each new titration or logging report, if the last character is a number.

Company Name: - Allows the company name to be recorded in each report.

AUXILIARY FUNCTIONS

- Operator Name* - Allows the operator name to be recorded in each report.
- Electrode Name* - Allows the electrode name to be recorded in each report.
- Fields 1, 2, 3* - Allows any additional information to be recorded in each report.

The fields that must be present in the Titration Report must be selected from the **Setup Titration Report** screen (see 8.3.7 *Setup Titration Report* section).

8.3.4 Instrumentation Data

Displays titrator configuration data.

Instrumentation Data			
HI902 Titrator			
SERIAL NUMBER			
Titrator Serial Number:		00123456	
Analog Board 1 Serial Number:		30000067	
Analog Board 2 Serial Number:		31012345	
Pump 1 Serial Number:		03407001	
SOFTWARE VERSION			
Titrator Software Version:		v1.2	
Base Board Software Version:		v1.0	
Pump 1 Software Version:		v1.4	
Analog 1 Calibration Date:	May 18, 2004		
Analog 2 Calibration Date:	Sep 09, 2004		
	Escape	Print	

Titrator Serial Number: Indicates the serial number of the titrator base board.

Analog Board 1 Serial Number: Indicates the serial number of the titrator analog board 1.

Analog Board 2 Serial Number: Indicates the serial number of the titrator analog board 2.

Pump 1 (and/or 2) Serial Number: Indicates the serial number of each connected pump.

Titrator Software Version: Indicates the current software version installed on the titrator.

Base Board Software Version: Indicates the current software version present on the base board of the titrator.

Pump 1 (and/or 2) Software Version: Indicates the current software version of the pumps.

Analog 1 Calibration Date: Indicates manufacturer calibration date of analog board 1.

Analog 2 Calibration Date: Indicates manufacturer calibration date of analog board 2.

Note: *If more than 1 year elapsed from the calibration date of the analog board 1 or 2, the message **Analog 1 Calibration Due** or **Analog 2 Calibration Due** will appear on the main screen and analog board recalibration must be performed.*

8.3.5 Logging Interval – pH/mV

Allows the user to setup a time interval for auto-logging while in pH or mV mode (see 7.3 *Logging* section).

8.3.6 Setup pH/mV Report

Customize a unique report to record the pH and mV measurements.

Setup pH/mV Report

Select fields to be saved in the report.

- * Result and Units
- * Potential
- * Temperature and Units
- * Date and Time
- * Standardization Data
- Sample Name
- Company Name
- Operator Name
- Electrode Name
- Field 1
- Field 2
- Field 3
- Software Versions
- Serial Numbers

Select	Escape	Save Report	
--------	--------	-------------	--

8.3.7 Setup Titration Report

Customize a unique report to record the titration results. An asterisk means that it will be included in the titration report.

Setup Titration Report

Select fields to be saved in the report.

- * Result and Units
- * Titration Method
- * Initial and Final Readings
- * Analyte Size
- * End Point Volume
- * Titration Duration
- * Date and Time
- * Titration Ended By
- All Data Points
- Method Parameters
- Standardization Data
- Sample Name
- Company Name
- Operator Name

Select	Escape	Save Report	Page Up	Page Down
--------	--------	-------------	---------	-----------

Chapter 9. Contents

9	MAINTENANCE, PERIPHERALS	9 - 3
9.1	Burette Maintenance	9 - 3
9.1.1	Burette Assembly	9 - 3
9.1.2	Changing Burette	9 - 3
9.1.3	Disassembling Burette	9 - 4
9.1.4	Assembling Burette	9 - 4
9.1.5	Cleaning Burette	9 - 5
9.1.6	Burette Preparation (Filling with Titrant)	9 - 7
9.2	Fuses Replacement	9 - 8
9.3	Peripherals	9 - 9
9.3.1	Connecting an External Display	9 - 9
9.3.2	Connecting an External PC Keyboard	9 - 9
9.3.3	Connecting a Printer	9 - 11
9.3.4	Connecting to a Computer	9 - 11

9 MAINTENANCE, PERIPHERALS

9.1 Burette Maintenance

9.1.1 Burette Assembly

The included burette is delivered with a 25 mL syringe inside and with all the accessories mounted (see *2.1 Unpacking* section for burette assembly details).

Note: *The dispensing tube has one flat-shaped end and the other one is equipped with a dispensing tip. (See 2.1 Unpacking section for the accessories list.)*

9.1.2 Changing Burette

Remove the burette from the pump assembly by sliding it back and then slide the new burette into place (see the picture below).

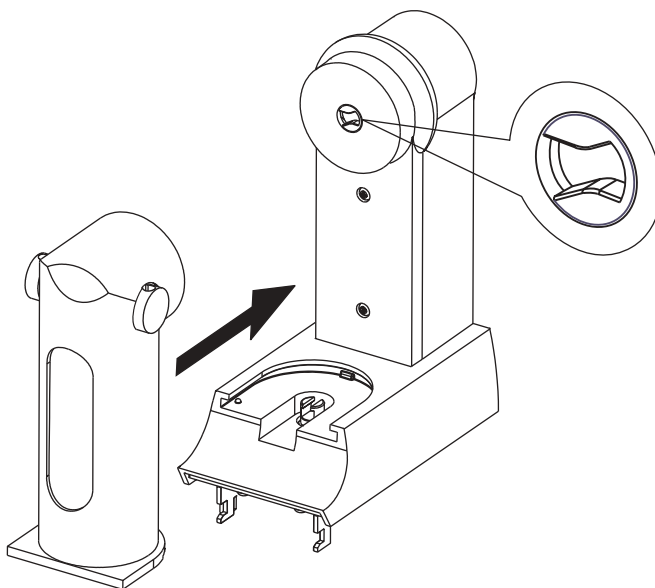

9.1.3 Disassembling Burette

To dismantle the dispensing tube and the aspiration tube follow these steps:

- Slide up the protection tube (4).
- Remove the tube lock (5) from the burette holder.
- Slide the mounting tool (3) over the dispensing tube.
- Unscrew the fitting (2).
- Remove the mounting tool (3) from the tube.
- Remove the tube.
- Repeat these steps for the aspiration tube.

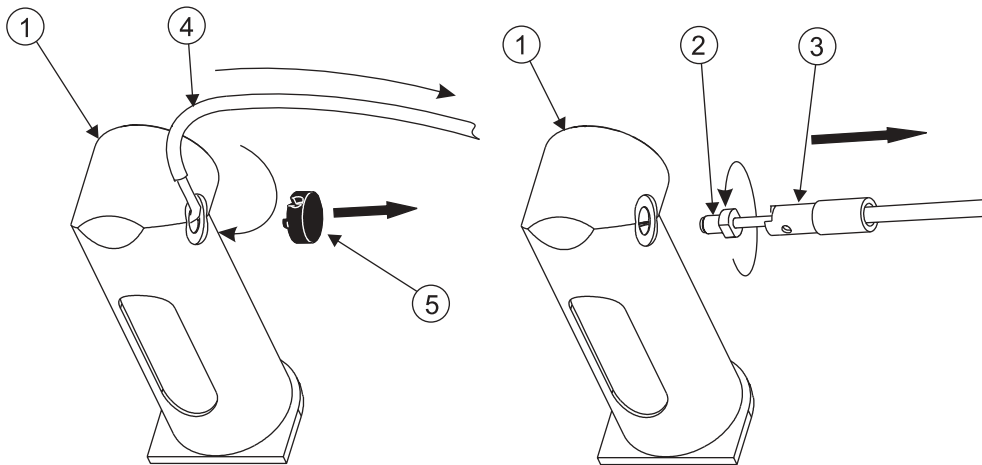

9.1.4 Assembling Burette

Both, the aspiration and the dispensing tube have a fitting and a protection tube. The aspiration tube will be mounted in the left side and the dispensing tube will be mounted in the right side of the burette (see diagram on the next page).

To attach the dispensing tube and the aspiration tube follow these steps:

- Slide the mounting tool (3) over the dispensing tube.
- Insert the flat-shaped end of the dispensing tube into the valve outlet.
- Screw in the fitting (2) with the mounting tool.
- Remove the mounting tool (3) from the tube.
- Bend the tube up into a vertical position.
- Press the tube lock (5) into the burette hole.
- Slide down tightly the protection tube (4) into the dedicated gap of the tube lock.
- Repeat these steps for the aspiration tube.

To attach the burette to the pump simply slide the burette into the pump support as shown in the figure presented in *9.1.2 Burette Changing* section.

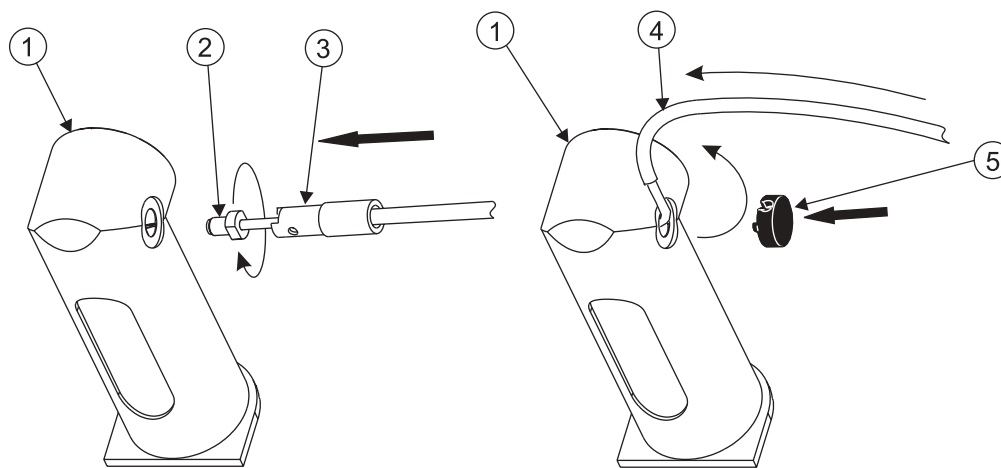

9.1.5 Cleaning Burette

To clean the burette, follow these steps:

- If the burette is filled with liquid, remove the aspiration tube from the titrant bottle and execute purge burette operation (see *8.1.4 Purge Burette* section).
- Insert the aspiration tube into cleaning solution and/or into deionized water or titrant solvent, depending on the chemical nature of titrant and the intended use of the burette. If a titration will follow, use titrant solvent to clean the tube.
- Execute prime burette operation to fill the burette (use 2 rinses) (see *8.1.1 Prime Burette* section).
- During second refilling of the burette remove the aspiration tube out of the solvent beaker and allow the air to replace the liquid in the burette. This will clean the aspiration tube.

If this simple cleaning procedure is not adequate for the desired purpose, continue with these steps:

- Slide the burette out from the pump assembly.
- Remove the tubes with the special mounting tool (tool for valve fitting and burette cap removal).
- Clean them separately or insert new ones.
- Remove the protective cap from the bottom by using the special tool.
- Remove the protective plastic shield.
- Remove the syringe from the burette assembly by unscrewing it with your fingers.
- Extract the piston from the syringe.

MAINTENANCE, PERIPHERALS

- Clean both the piston and the syringe with appropriate solvents, then with ethylic alcohol and then rinse them several times with deionized water, titrant solvent or just titrant.
- Remove the excess liquid.

Warning: Avoid contact with the titrant with bare hands.

Avoid spilling titrant in the working place.

Clean the external side of the syringe and piston to remove aggressive chemicals. Do not touch the Teflon part of the piston and internal walls of the burette with bare hands or greasy materials.

- Reinsert the piston into the syringe.
- Reinsert the syringe by screwing it in the valve with your fingers.
- Reinsert the protective cap to the bottom of the burette assembly. Carefully position the cap into the burette.
- Slide the burette into the burette stand. Notice the position of the piston shaft to the pump couple.
- A final rinse with titrant is recommended if the cleaning is followed by a titration.

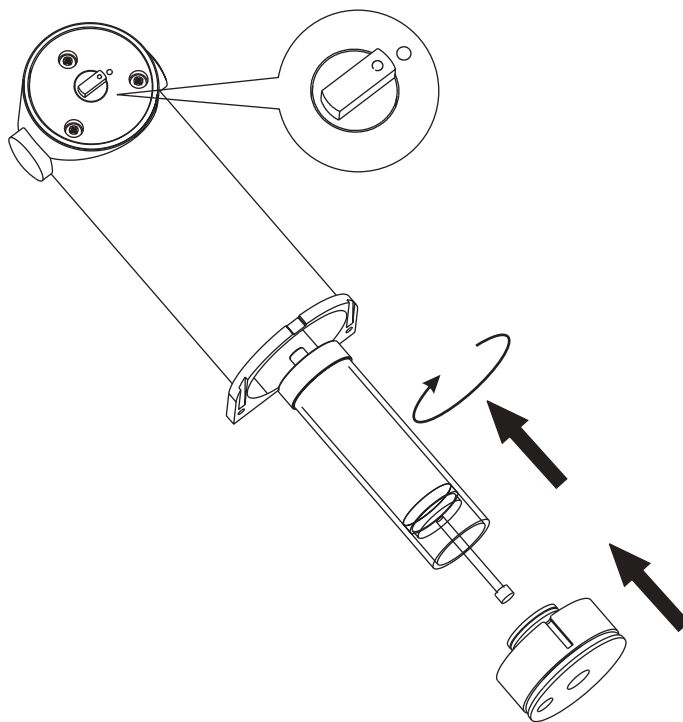

9.1.6 Burette Preparation (Titrant Filling)

Before starting a titration, the burette must be properly filled with titrant in order to obtain a good and repeatable result. To fill the burette, follow the next steps and recommendations:

- If necessary, clean the burette and make sure it is empty.
- From the main screen press .
- Highlight *Prime Burette* option and press .
- Enter the number of times the burette needs to be rinsed (minimum three rinses are recommend allowing air bubbles to be evacuated).
- Press .
- Insert the aspiration tube into the titrant bottle only when the piston is going down and has reached about $\frac{1}{4}$ from the upper end.

To avoid the presence of the air bubbles inside the burette, make sure to have a continuous liquid flow inside the burette and a little air zone just above the liquid level at the first filling movement. The next upward movement will evacuate the entire air. This way no air will be left in the valve.

Sometimes during the Prime Burette process, slight finger tapping on the tubes is helpful to evacuate captive air bubbles.

If air bubbles are still present:

- Remove the aspiration tube from the titrant bottle.
- Repeat burette preparation procedure.
- If no success, clean the burette again.

9.2 Fuses Replacement

To replace the fuses, follow these steps:

- Turn off the titrator.
- Remove the power cord from the power connector located on the rear side of the titrator case.
- With a screw driver open the fuse holder lid.

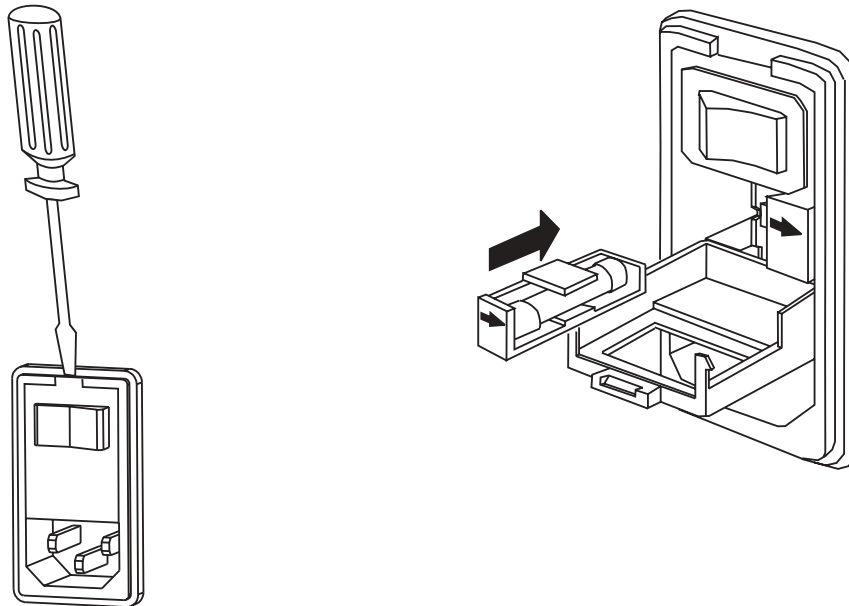

- Extract the fuse holder.
- Replace the fuses (for recommended fuses replacement please see the label located above the main power switch).
- Close the fuse holder lid.
- Connect the power cord.

Note: For other maintenance operations please contact your dealer or the nearest Hanna Customer Service Center.

9.3 Peripherals

Warning! Connection/disconnection of POWER CORD, PUMP ASSEMBLY, EXTERNAL PC DISPLAY, PRINTER, RS232 INTERFACE, EXPANSION DEVICE must be done only when titrator and external devices are turned off.

9.3.1 Connecting an External Display

The information shown on the titrator display can be viewed also on a Standard VGA display connected with a 15-pin cable, as presented below.

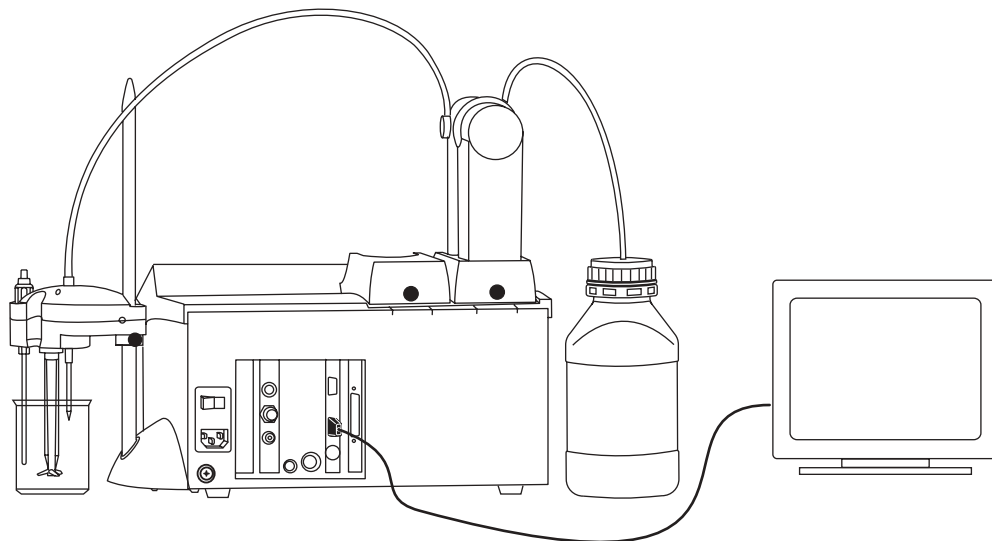

Connect the external display to the display socket.
Turn on the titrator and then the external display.

9.3.2 Connecting an External PC Keyboard



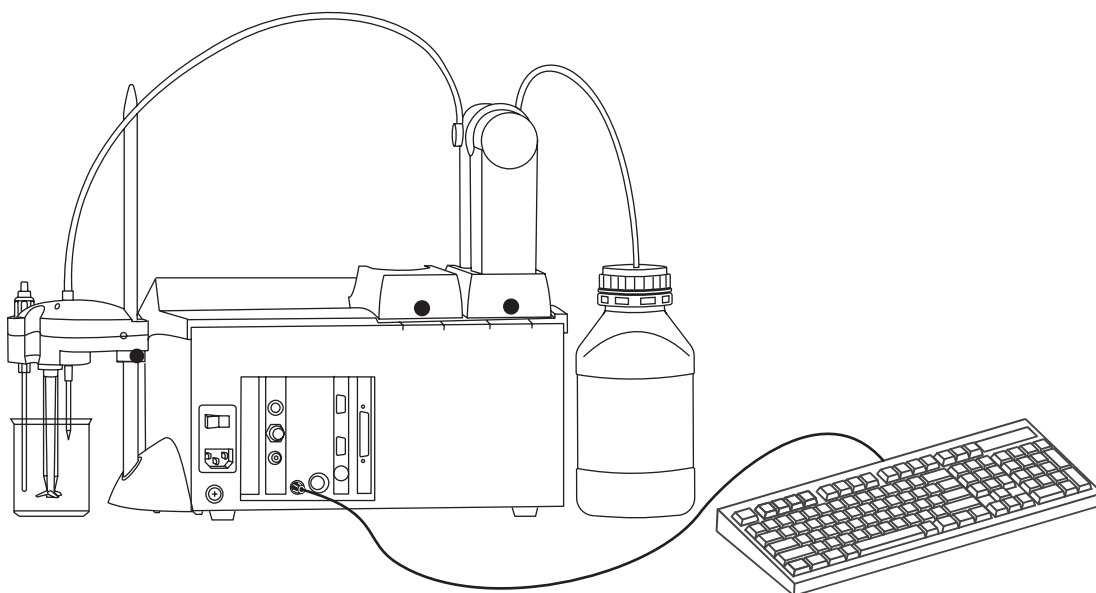











This connection allows you to use an external PC Keyboard in addition to titrator's keypad.



Connect an external PC Keyboard having a 6-pin Mini DIN connector.

MAINTENANCE, PERIPHERALS

The correspondence between the Titrator's Keypad and the United States 101-type external keyboard are:

External PC Keyboard (United States 101)	Titrator Keypad
Function Key F-1	
Function Key F-2	
Function Key F-3	
Function Key F-4	
Function Key F-5	Option Key 1 (from left to right)
Function Key F-6	Option Key 2 (from left to right)
Function Key F-7	Option Key 3 (from left to right)
Function Key F-8	Option Key 4 (from left to right)
Function Key F-9	Option Key 5 (from left to right)
Function Key F-10	
Arrow Key: Up	
Arrow Key: Down	
Arrow Key: Left	
Arrow Key: Right	
Page Up	
Page Down	
Numeric Keys: 0 to 9	
Tab	
Enter	
Alphanumeric Keys	Allow alphanumeric entries.

9.3.3 Connecting a Printer

A variety of parallel printers can be connected to the parallel port of the titrator using a standard DB25-pin cable.

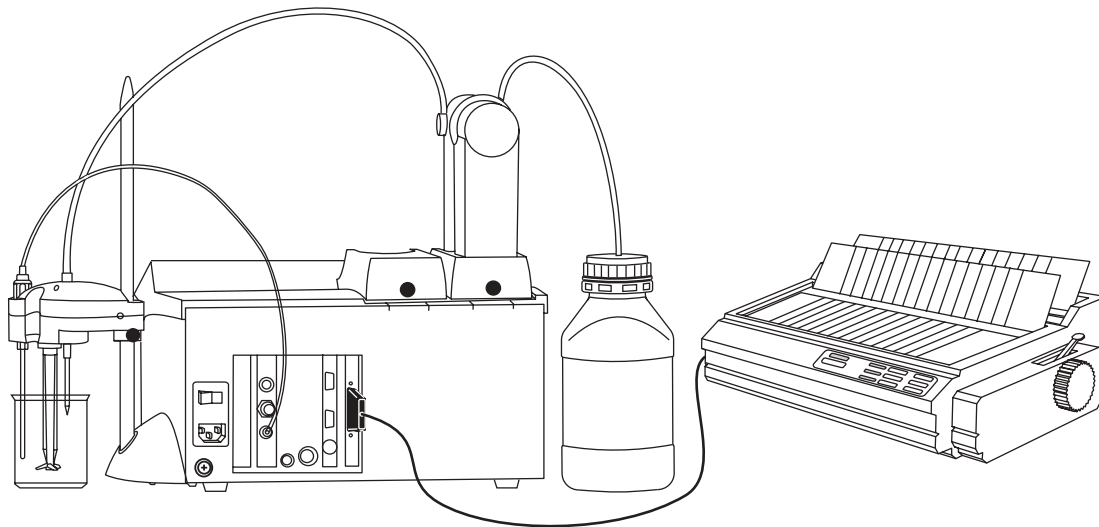

Warning: The titrator and the external printer must be both turned OFF from the main switch before making the connection.

Connect the external printer to the standard 25-pin Socket.
Turn on the titrator and then the printer.

9.3.4 Connecting to a Computer

The titrator can be connected to a computer using a standard serial cable with a standard DB9 pin connector. HI 900 PC application needs to be installed on the PC.

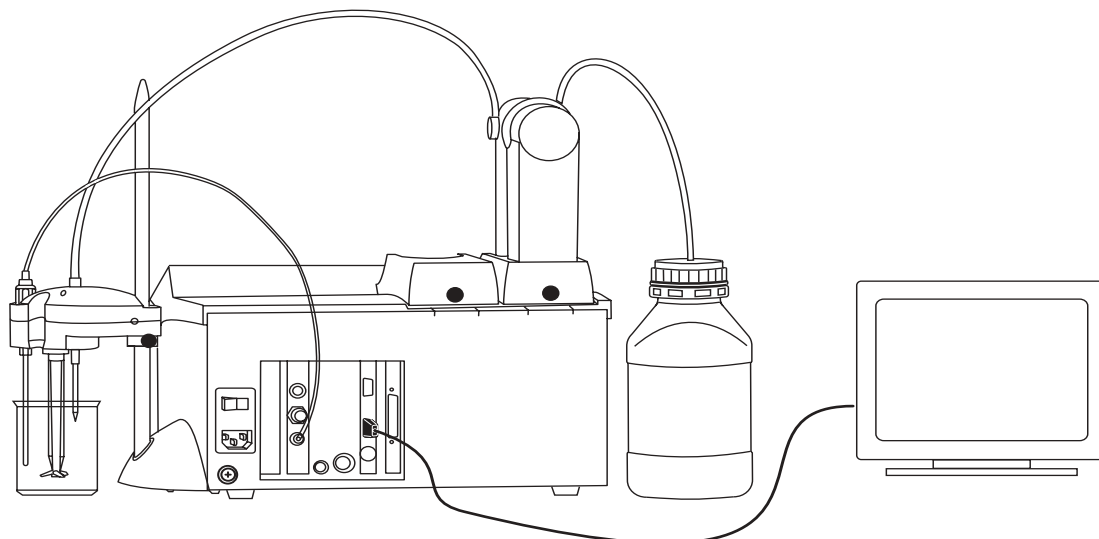

MAINTENANCE, PERIPHERALS

Warning: *The titrator and the external PC must be both turned OFF from the main switch before making the connection.*

Connect the cable to the standard DB9 pin Socket.

Connect the cable to the serial communication port on the PC.

Turn on the titrator and then the computer.

Select the **Serial Communication** screen on the titrator following the path:

General Options - Serial Link with PC - Serial Communication

Launch the HI 900 PC application and then select the appropriate serial port on the PC.

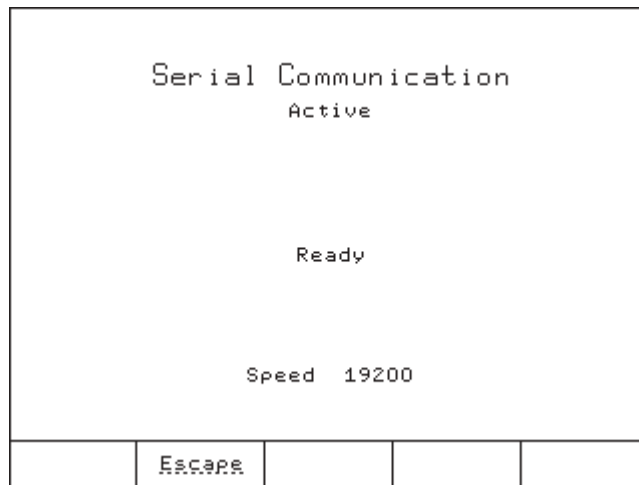

The HI 900 PC application allows the transfer of a variety of information between titrator and PC.

Appendix 1. Contents

A1 TECHNICAL SPECIFICATIONS A1-3

A1 TECHNICAL SPECIFICATIONS

mV	Range	- 2000.0 to 2000.0 mV	
	Accuracy	±0.1 mV	
	Resolution	0.1 mV	
pH	Range	- 2.000 to 20.000 pH	
	Accuracy	±0.001 pH	
	Resolution	0.1 / 0.01 / 0.001 pH	
Temperature	Range	- 5.0 to 105.0 °C	
		23.0 to 221.0 °F	
		268.2 to 378.2 K	
	Accuracy	±0.1 °C	
	Resolution	0.1 °C	
Dosing Accuracy		0.1 % of full nominal volume of the burette	
Display Resolution		0.001 mL	
Burette Sizes	5 mL	Accuracy:	± 5 µL
	10 mL	Accuracy:	± 10 µL
	25 mL	Accuracy:	± 25 µL
	50 mL	Accuracy:	± 50 µL
Graphic Display		7.5" B/W graphical display with backlight.	
Languages		English, Italian, Portuguese.	
Methods		up to 100 (standard and user methods)	

Burette size auto-detection and interchangeable burettes. The titrator automatically detects the size of the burette when it is slid in the pump assembly.

Propeller Stirrer-Programmable Stirring Speed. 100-2500 RPM, automatically held with a 100 RPM accepted tolerance.

Flow Rate: user-selectable (see 5.5.21 *Volume/Flow Rate* section for ranges).

Direct mV / pH Measurement.

Automatically Temperature Compensated pH Measurements.

pH Calibration with up to 5 buffers using *Auto-Entry* or *Manual-Entry* options; temperature compensated buffers are internally stored for *Auto-Entry* option.

Potentiometric Titrations: Acid-Base (pH or mV-Mode), Redox, Precipitation, Complexometric, Non-Aqueous, Ion-Selective, Argentometric, Voltametric (imposed current)

APPENDIX 1

Titer Determination.

Fixed mV or pH End Point Detection.

Single Equivalence Point Detection, with the 1st or 2nd Derivatives of the titration curve.

Multiple Equivalence Point Detection (HI 902 only)

Flexible Concentration Calculations, with many concentration units.

Display of the Graphs during titration, graphs of the stored titration data (mV-Volume or pH-Volume titration curve, 1st derivative curve or 2nd derivative curve, in pH-mode or mV-mode) and pH/mV values versus time-data logging results.

Data Storage: up to 100 complete titration report and pH/mV logging complete reports.

Files Copied to and Restored from Floppy Disk: Standard Methods, User Methods, Titration and pH/mV Logging Reports, Graphic Bitmap Files can be transferred to and from floppy disk using the 3.5" Floppy Disk unit of the titrator.

Peripheral Units Attachment Possibilities:

- External VGA Display
- External PC Keyboard
- Printer
- RS232 interface

GLP Conformity: Good Laboratory Practice and Instrumentation Data storage and printing capabilities.

Mains: 110/220 Vac ; 50-60 Hz

Power Draw: 1.3 A

2 Exchangeable Fuses

Enclosure Material: Polycarbonate plastic and Steel

Keypad: Polycarbonate

Dimensions: Width x Depth x Height = 390 x 350 x 380 mm

Weight: approx. 10 Kg (with 1 pump, stirrer and sensors)

Operating Environment: 10 to 40 °C, up to 95% relative humidity

Storage Environment: -20 to 70 °C, up to 95% relative humidity

Appendix 2. Contents

- A2 BACK TITRATION (HI 902 only)A2-3**
- A2.1 Applicability Domain A2-3**
- A2.2 Method PrinciplesA2-3**
- A2.3 Back Titration Example A2-3**
- A2.3.1 Introduction A2-3
- A2.3.2 Setting Up the Method Parameters A2-4
- A2.3.3 Preparing the Sample A2-5
- A2.3.4 Perform the Titration A2-5

A2 BACK TITRATION (HI 902 only)

A2.1 Applicability Domain

Back titrations are generally used for one of these reasons:

- Reaction kinetics are too slow for the direct titration of the analyte.
- The metal precipitates at the desired pH (complexometric titrations).
- The reaction between titrant and analyte produces some auxiliary compounds (e.g. CO₂) that can affect the mV signal and also the equivalence point detection.
- Heavily soluble analyte in the solvents used.
- Titrations with more flat first derivative curves.

A2.2 Method Principles

In a back titration, an excess of a reagent is added to the sample solution, helping to lead the reaction to its completion. The unreacted excess reagent is then titrated. The difference between the total reagent first added and that determined from the final titration is the quantity of reagent required to complete the reaction with the analyzed compound from the sample. With this reagent quantity will be calculated the sample concentration. The back titration can be an acid – base, complexometric, redox etc.

A2.3 Back Titration Example

An example of back titration might be the determination of an antacid neutralizing capacity.

A2.3.1 Introduction

An excess of stomach acid (primarily HCl) causes heartburn and acid indigestion. Commercial antacids consist of a number of ingredients, such as binders and flavorings, but the active ingredient is simply a basic salt such as Mg(OH)₂ (milk of magnesia), NaHCO₃ (sodium bicarbonate), CaCO₃ (calcium carbonate) or Al(OH)₃ (aluminum hydroxide), to neutralize the acid. In this experiment we will analyze a typical antacid containing CaCO₃, which reacts with an acid to form a salt, water and a gas:

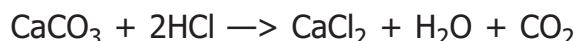

A conventional acid/base titration is very difficult in this case as the active ingredient is less soluble in water, and the CO₂ gas formed has an important influence in pH measurements.

In order to overcome this limitation we will completely dissolve the tablets in excess acid:

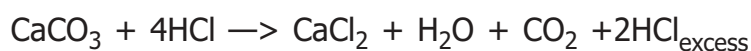

APPENDIX 2

and back titrate the remaining acid with NaOH to determine the amount of CaCO₃ present.

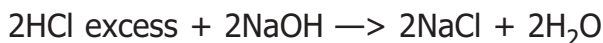

In order to obtain an accurate value for the concentration of the titrated antacid, we need to know the exact concentration of NaOH and HCl used.

The final concentration is expressed as mg/g CaCO₃.

A1.3.2 Setting Up the Method Parameters

Use the following parameters to program the method (see *5.5 Method Options* section):

Name:	Antacid Power
Titration Type:	Back-Titration
Titrant 1 pump:	Pump 1
Titrant 2 pump:	Pump 2
Break at titrant change:	YES
Dosing Type:	Dynamic
min Vol:	0.010 mL
max Vol:	0.500 mL
delta E:	4.500 mL
End Point Mode:	pH 1EQ points, 1st Der
Recognition Option:	
Threshold:	500 mV / mL
Range:	NO
Filtered Derivatives:	NO
Pre-Titration Volume:	0.000 mL
Pre-Titration Stir Time:	5 Sec
Measurement Mode:	Signal Stability
delta E:	0.3 mV
delta t:	1.5 Sec
t min wait:	5 Sec
t max wait:	15 Sec
Electrode Type:	pH
Calculations:	Sample Calc. by Weight
Titrant 1 Units	M (mol/L)
Titrant 2 Units	M (mol/L)
Final Result Units	g/g
Titrant 1 Name:	HCl
Titrant 1 Conc.:	1 M(mol/L)
Titrant 2 Name:	NaOH
Titrant 2 Conc.:	1 M(mol/L)
Analyte Size:	0.5 g
Analyte Entry:	Manual
Titrant 1 Entry:	Calculated
Maximum Titrant 2 Volume:	25.000 mL
Stirring Speed:	1500 RPM
Potential Range:	-2000.0 to 2000.0 mV
Flow Rate:	30.0 mL/min
Signal Averaging:	1 Reading

In order to start the analysis, both burettes must be filled with needed reagents, as follows:

- Pump 1 must have attached a burette filled with HCl 1 M (mol/L).
- Pump 2 must have attached a burette filled with NaOH 1 M (mol/L).

A2.3.3 Preparing the Sample

For this analysis can use commercial antacid pills.

- Crush a few pills in a mortar and separate a quantity weighting around 0.5 mg from the resulting powder.
- Pour about 20 mL distilled and deionized water into a 150 mL beaker and then add the sample powder.
- Raise the stirrer assembly.
- Place the beaker under the stirrer assembly.
- Lower the stirrer assembly until it rests on its positioning collar.
- Adjust the height of the stirrer by using the positioning screw of the positioning collar to have the propeller as close as possible to the bottom of the beaker.
- Adjust the level of the sample solution so that the pH electrode bulb is completely immersed in the sample and the reference junction of the electrode is 5-6 mm below the surface.

A2.3.4 Perform the Titration

- If the method is selected (the main screen displays "Antacid Power" at method name) press .
- The titrator will prompt for the sample weight. Enter the exact weight value (with 4 digits) and press .
- The calculated volume of titrant 1 is displayed (this value can be modified by the user). The displayed volume will be dispensed during the first phase of back-titration.
- Press to proceed with the next step.
- The titrator will start to dispense the titrant 1 (HCl).
- When this phase is completed, the titrator will stop and the **Continue Back Titration** screen is displayed.

Continue Back Titration				
The pump used for second phase is:				
Active Pump: Pump 2				
Timer 00:00:00				
Press "Continue" to start the second phase or "Abort" to cancel.				
Continue	Abort	Select Pump	Burette	Reset Timer

APPENDIX 2

- Slide the stirrer assembly up.
- Put the beaker on a hotplate.
- Heat gently until all the effervescence has ceased, then boil it for 1-2 minutes. Some of the inactive tablet material may not dissolve; however, this should not interfere with the titration.
- Cool the solution to the room temperature and put the beaker under the stirrer assembly.
- Lower the stirrer assembly until it rest on its positioning collar.
- Adjust the height of the stirrer by using the positioning screw of the positioning collar to have the propeller as close as possible to the bottom of the beaker.
- Press to proceed to the second phase of the analysis.
- This phase is a normal equivalence point titration.

Appendix 3. Contents

A3 MULTIPLE EQUIVALENCE POINTS (HI 902 only) A3-3

A3.1 Applicability Domain A3-3

A3.2 Perform a Multi-Equivalence Point Titration A3-3

A3.3 Titration Example A3-4

A3 MULTIPLE EQUIVALENCE POINTS (HI 902 only)**A3.1 Applicability Domain**

In case of:

- determining the components concentration from a synthetic mixture (e.g. Mixture of HCl, CH₃COOH, NH₄Cl).
- determining the concentration of a polyprotic acid in its titrable ionization stages (e.g. H₃PO₄, two equivalence points in aqueous medium).

A3.2 Perform a Multi-Equivalence Point Titration

With the information provided above, set up the method parameters as follows:

- Set the end point mode as equivalence end point (mV or pH).
- Set the number of equivalence points (up to 5 points) to be found.

Number of Equivalence Points				
Enter the number of equivalence points to be found.				
3 points				
The range is between 1 and 5 equivalence points.				
Accept	Escape	Delete Digit		

- Select the end point determination (like in standard titration).
- Set the rest of method parameters and save the modification.

A3.3 Titration Example

As an example of a multi-equivalence point titration we take the titration of a mixture containing HCl, CH₃COOH and NH₄Cl with Sodium Hydroxide.

During this type of titration the user is able to view the following information:

- After first equivalence point is detected, the titration screen will show View Details and the number of equivalence points detected.

16:17:25 Nov 12, 2003

HCl + NH₄Cl + CH₃COOH

3.1328E-2 N (eq/L)

EQ points detected: 1 1500/1500 RPM

In Progress

ATC	Burette: 25 mL	Unstable
35.2 °C	Volume Delivered	mV
	0.727 mL	181.6

View Details	View Curve	Suspend	Stop
---	------------	---------	------

By pressing View Details the titrator will display ***EQ Points Report***. This screen contains information about all the equivalence points detected.

EQ Points Report

	mV	Volume [mL]	Results [N (eq/L)]
EQ1:	228.4	0.393	3.6710E-2

Escape		
--------	--	--

- The graph displays the equivalence points with a cross. Near each cross the equivalence titrant volume is displayed. The volume is calculated:
 - from titration beginning (for the first equivalence point marked with a cross).

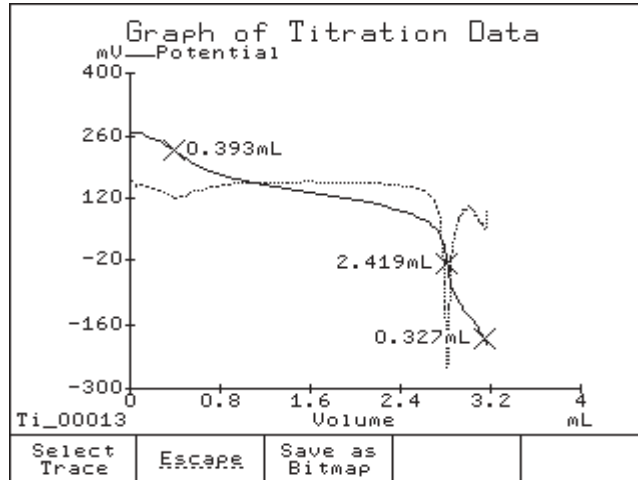

- the next volumes (marked with a cross) are calculated as the difference between the total volume dispensed until the current equivalence point is reached) and the sum of the already detected equivalence points.

The concentration is calculated with the formula selected in the *Calculations* option from the **View / Modify Method** screen.

Appendix 4. Contents

A4 ACCESSORIES A4-3

A4.1 Solutions A4-3

A4.1.1 pH Calibration SolutionsA4-3

A4.1.2 pH Calibration Solutions in FDA Approved Bottle A4-3

A4.1.3 Electrode Cleaning SolutionsA4-3

A4.1.4 Electrode Cleaning Solutions in FDA Approved Bottle A4-4

A4.1.5 Electrode Storage Solutions A4-4

A4.1.6 Electrode Storage Solutions in FDA Approved BottleA4-4

A4.1.7 Refilling Electrolyte SolutionsA4-4

A4.1.8 Refilling Electrolyte Solutions in FDA Approved Bottle A4-4

A4.1.9 ORP Pretreatment Solutions A4-4

A4.1.10 Titration Reagents A4-4

A4.2 Sensors A4-5

A4.2.1 pH Electrodes A4-5

A4.2.2 ORP Electrodes A4-6

A4.2.3 Half-cell Electrodes A4-6

A4.2.4 Extension Cable for Screw-Type Electrodes onlyA4-7

A4.3.5 Temperature Sensor A4-7

A4.3 Titrator components A4-8

A4 ACCESSORIES**A4.1 Solutions****A4.1.1 pH Calibration Solutions**

HI 70004C	—>	pH 4.01 Buffer Solution, 20 mL
HI 77400C	—>	pH 4.01 & 7.01 Buffer Solution, 20 mL each
HI 7004M	—>	pH 4.01 Buffer Solution, 230 mL
HI 7004L	—>	pH 4.01 Buffer Solution, 500 mL
HI 7006M	—>	pH 6.86 Buffer Solution, 230 mL
HI 7006L	—>	pH 6.86 Buffer Solution, 500 mL
HI 70007C	—>	pH 7.01 Buffer Solution, 20 mL
HI 7007M	—>	pH 7.01 Buffer Solution, 230 mL
HI 7007L	—>	pH 7.01 Buffer Solution, 500 mL
HI 7009M	—>	pH 9.18 Buffer Solution, 230 mL
HI 7009L	—>	pH 9.18 Buffer Solution, 500 mL
HI 770710C	—>	pH 10.01 & 7.01 Buffer Solution, 20 mL each
HI 7010M	—>	pH 10.01 Buffer Solution, 230 mL
HI 7010L	—>	pH 10.01 Buffer Solution, 500 mL
HI 7001M	—>	pH 1.68 Buffer Solution, 230 mL
HI 7001L	—>	pH 1.68 Buffer Solution, 500 mL

A4.1.2 pH Calibration Solutions in FDA Approved Bottle

HI 8004L	—>	pH 4.01 Buffer Solution, 500 mL
HI 8006L	—>	pH 6.86 Buffer Solution, 500 mL
HI 8007L	—>	pH 7.01 Buffer Solution, 500 mL
HI 8009L	—>	pH 9.18 Buffer Solution, 500 mL
HI 8010L	—>	pH 10.01 Buffer Solution, 500 mL

A4.1.3 Electrode Cleaning Solutions

HI 7061M	—>	General Purpose Solution, 230 mL
HI 7061L	—>	General Purpose Solution, 460 mL
HI 7073M	—>	Protein Cleaning Solution, 230 mL
HI 7073L	—>	Protein Cleaning Solution, 460 mL
HI 7074M	—>	Inorganic Cleaning Solution, 230 mL
HI 7074L	—>	Inorganic Cleaning Solution, 460 mL
HI 7077M	—>	Oil & Fat Cleaning Solution, 230 mL
HI 7077L	—>	Oil & Fat Cleaning Solution, 460 mL

APPENDIX 4

A4.1.4 Electrode Cleaning Solutions in FDA Approved Bottle

HI 8061M	—>	General Purpose Solution, 230 mL
HI 8061L	—>	General Purpose Solution, 460 mL
HI 8073M	—>	Protein Cleaning Solution, 230 mL
HI 8073L	—>	Protein Cleaning Solution, 460 mL
HI 8077M	—>	Oil & Fat Cleaning Solution, 230 mL
HI 8077L	—>	Oil & Fat Cleaning Solution, 460 mL

A4.1.5 Electrode Storage Solutions

HI 70300M	—>	Storage Solution, 230 mL
HI 70300L	—>	Storage Solution, 460 mL

A4.1.6 Electrode Storage Solutions in FDA Approved Bottle

HI 80300M	—>	Storage Solution, 230 mL
HI 80300L	—>	Storage Solution, 460 mL

A4.1.7 Refilling Electrolyte Solutions

HI 7071	—>	3.5M KCl + AgCl Electrolyte, 30 mL, for single junction electrodes
HI 7072	—>	1M KNO ₃ Electrolyte, 30 mL
HI 7082	—>	3.5M KCl Electrolyte, 30 mL, for double junction electrodes

A4.1.8 Refilling Electrolyte Solutions in FDA Approved Bottle

HI 8071	—>	3.5M KCl + AgCl Electrolyte, 30 mL, for single junction electrodes
HI 8072	—>	1M KNO ₃ Electrolyte, 30 mL
HI 8082	—>	3.5M KCl Electrolyte, 30 mL, for double junction electrodes

A4.1.9 ORP Pretreatment Solutions

HI 7091M	—>	Reducing Pretreatment Solution, 230 mL
HI 7091L	—>	Reducing Pretreatment Solution, 460 mL
HI 7092M	—>	Oxidizing Pretreatment Solution, 230 mL
HI 7092L	—>	Oxidizing Pretreatment Solution, 460 mL

A4.1.10 Titration Reagents

HI 70455	—>	0.01 N NaOH Titration Reagent, 1 L
HI 70456	—>	0.1 N NaOH Titration Reagent, 1 L
HI 70457	—>	1 N NaOH Titration Reagent, 1 L
HI 70458	—>	0.01 M H ₂ SO ₄ Titration Reagent, 1 L
HI 70459	—>	0.05 M H ₂ SO ₄ Titration Reagent, 1 L
HI 70462	—>	0.01 N HCl Titration Reagent, 1 L
HI 70463	—>	0.1 N HCl Titration Reagent, 1 L
HI 70464	—>	1 N HCl Titration Reagent, 1 L

A4.2 Sensors

A4.2.1 pH Electrodes

HI 1043B / HI 1040S

Glass-body, double junction, refillable, combination pH electrode.

Use: strong acid/alkali.

HI 1053B / HI 1050S

Glass-body, triple ceramic, conic shape, refillable, combination pH electrode.

Use: emulsions.

HI 1083B

Glass-body, micro, Viscolene, nonrefillable, combination pH electrode.

Use: biotechnology, micro titration.

HI 1131B / HI 1111S

Glass-body, single junction, refillable, combination pH electrode.

Use: general purpose.

HI 1330B / HI 1310S

Glass-body, semimicro, single junction, refillable, combination pH electrode.

Use: laboratory.

HI 1331B / HI 1311S

Glass-body, semimicro, single junction, refillable, combination pH electrode.

Use: flasks.

HI 1230B / HI 1210S

Plastic-body (Ultem[®]), double junction, gel-filled, combination pH electrode.

Use: general purpose.

HI 2031B / HI 2020S

Glass-body, semimicro, conic, refillable, combination pH electrode.

Use: semisolid products.

HI 1332B / HI 1312S

Plastic-body (Ultem[®]), double junction, refillable, combination pH electrode.

Use: general purpose.

FC 100B

Plastic-body (Kynar[®]), double junction, refillable, combination pH electrode.

Use: general purpose for food industry.

FC 200B / FC 200S

Plastic-body (Kynar[®]), single junction, conic, Viscolene, refillable, combination pH electrode.

Use: meat & cheese.

APPENDIX 4

FC 210B

Glass-body, double junction, conic, Viscolene, combination pH electrode.
Use: milk, yogurt.

FC 220B

Glass-body, single junction, refillable, combination pH electrode.
Use: food & wine processing.

FC 911B

Plastic-body (Kynar[®]), double junction, refillable with built-in amplifier, combination pH electrode.
Use: very high humidity.

HI 1413B / HI 1410S

Glass-body, single junction, flat tip, Viscolene, combination pH electrode.
Use: surface measurement.

A4.2.2 ORP Electrodes

HI 3131B / HI 3111S

Glass-body, refillable, combination platinum ORP electrode.
Use: titration.

HI 3230B / HI 3210S

Plastic-body (Ultem[®]), gel-filled, combination platinum ORP electrode.
Use: general purpose.

HI 4430B / HI 4410S

Plastic-body (Ultem[®]), gel-filled, combination gold ORP electrode.
Use: general purpose.

A4.2.3 Half-cell Electrodes

HI 2110B

Glass-body, single half-cell pH electrode.
Use: general purpose.

HI 5311

Glass-body, Ag/AgCl reference half-cell electrode, double junction, refillable with 4mm banana plug with 1m (3.3') cable.
Use: general purpose with wide temperature range.

HI 5412

Glass-body, single Calomel reference half-cell electrode, refillable with 4mm plug with 1m (3.3') cable.
Use: general purpose with constant temperature range.

A4.2.4 Extension Cable for Screw-Type Electrodes only
(Screw to BNC Connector)**HI 7855/1**

Extension cable 1m (3.3') long.

A4.2.5 Temperature Sensor**HI 7662-T**

Temperature probe with 1 m (3.3') paneled cable.

Ultem[®] is registered Trademark of "General Electric Co."
Kynar[®] is registered Trademark of "Pennwalt Corp."

APPENDIX 4

A4.3 Titrator components

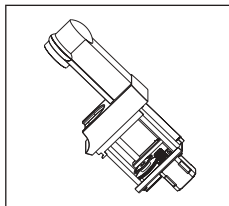

Pump assembly

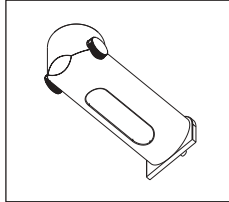

Burette (25 mL syringe)

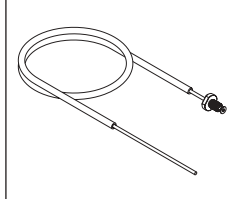

Aspiration tube with fitting and protection tube

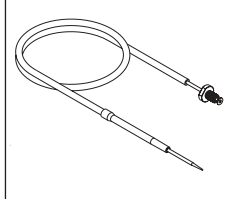

Dispensing tube with normal dispensing tip, fitting, protection tube and tube guide

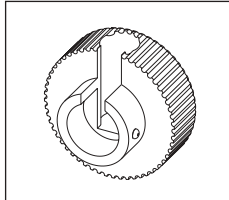

Tube locks

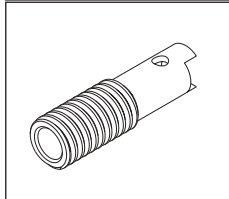

Tool for valve fitting and burette cap removal

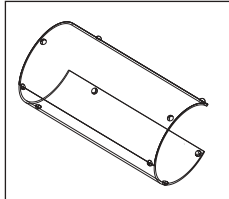

Light spectrum protection screen

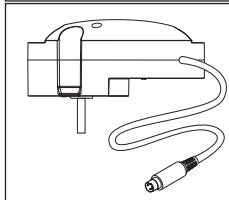

Overhead Stirrer

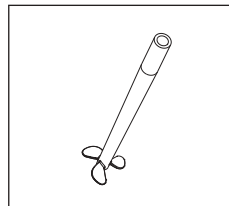

Propeller

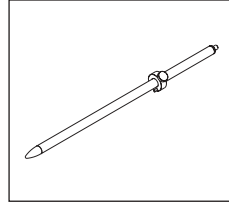

Stirrer support with positioning collar and positioning screw

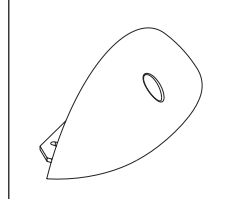

Stirrer stand

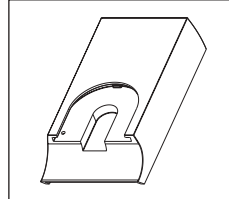

Burette blank support

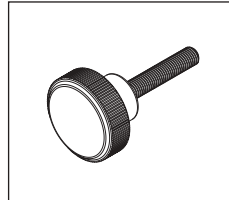

Pump and burette locking screw with plastic head

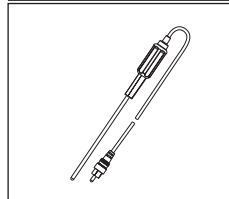

Temperature Probe

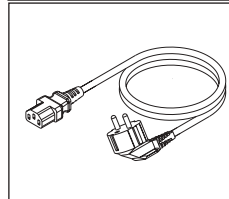

Power Cable

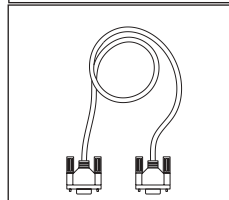

RS232 Cable

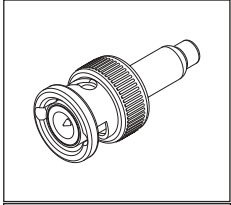

Shorting cap

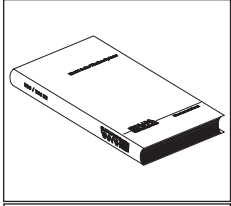

Instruction Manual Binder

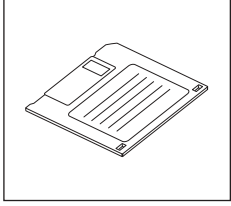

Start-up Disk (FDD with Titrator Installation Kit)

MAN901/902
09/04 R0